

SINCE 2009

# SYSTEM CARE

Tel : +971 2 6797507, Mob: +971 55 3115259,  
P.O Box: 53173, Musaffah Industrial Area (M-39)  
E-mail: [systemcareprinting@gmail.com](mailto:systemcareprinting@gmail.com)  
[www.systemcarep.com](http://www.systemcarep.com)



# Pipe Marking



Any vapor or gas under pressure that does not fit a category above

White on Black

White on Gray

White on Purple

Black on White

## Pipe Marker Placement



Label placement in relation to point of normal approach

Size Chart		
Outside pipe diameter w/cover	Minimum Length field color	Min. letter height
.75"-1.25"	8"	5"
1.5"-2"	8"	.75"
2.5"-6"	12"	1.25"
8"-10"	24"	2.5"
Over 10"	32"	3.5"

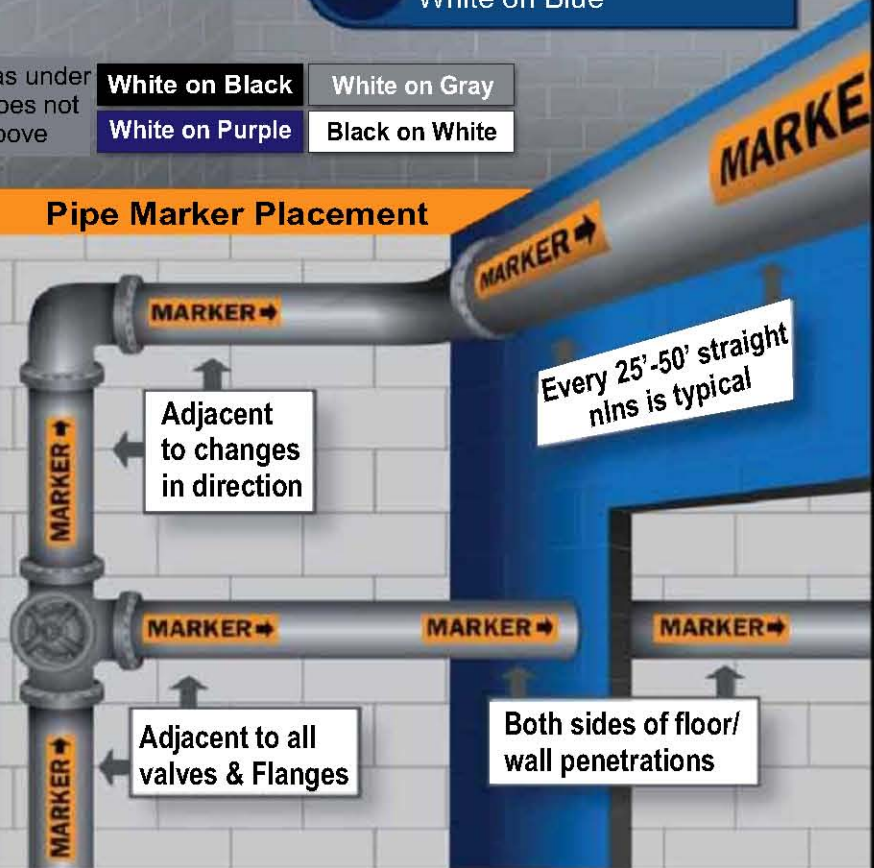



## Pipe Marking

### Introduction

Pipe markers provide people in the workplace, an awareness of what containers and pipes carry, as well as potential hazards associated with the pipe contents. Pipe markers also help to improve productivity and safety. They help to ensure that the proper pipe lines are isolated for maintenance and the correct valves are closed.

Employers must mark pipes that convey dangerous substances in order to comply with the health & Safety (Safety Signs & Signals) Regulations 1996. These regulations govern the shape, color & pattern of signs for pipe marking. Also employers must assess the risks derived from hazardous substances within pipe work to comply with the Control of Substances Hazardous to Health Regulations 2002.

At a glance it is not possible to see what substance is flowing through a pipe, what direction it is moving, or what pressure it is under and therefore identifying these factors by labelling the pipes makes risk assessment much easier. EC Directive 92/58/EEC requires that all visible pipes containing or conveying dangerous substances and preparations be labelled with a symbol or pictogram against a colored background.



# PIPE MARKING LABELS



## BS 1710:1984 & BS 4800

# Pipe marking & Identification according to BS 1710:1984 & BS 4800

## The British Standard

British Standard 1710 (BS 1710) provides the standards for identifying pipes, including color coding, label locations and information about pipe contents. The BS 1710 pipe marking standard is written to be in alignment with the international ISO/R 508 standard "Identification Colors For Pipes Conveying Fluids in Liquid or Gaseous Conditions in Land Installations and on board Ships" However, BS 1710 provides for the option of using user defined supplemental colors for 'other liquids' and specifies marking for ventilation ducts and electrical conduits. BS 1710 also specifies pipe marking for medical gases and refrigerants. This makes the British 1710 pipe marking standard an all-encompassing standard.

The BS 1710 pipe marking standard applies to pipes carrying fluids that are located above ground and to generic pipes on ships. It requires that, at a minimum, pipe marking must be located on both sides of valves, service appliances, bulkheads, wall and floor penetrations, as well as any other place pipe content identification is needed.

## BS 1710 Pipe Content Information - Code Indications

BS 1710 is the British Standard that specifies the colors for identification of pipes conveying fluids in above ground installations and on board ships on a generic basis. The standard requires information to be displayed in one and/or a combination of the following systems:

- (a) The full name of the pipe content.
- (b) The common abbreviation of the name.
- (c) The chemical symbol.
- (d) The refrigerant number as specified in British Standard 4580.-
- (e) The appropriate color bands (including specific color coding specified for medical and general building services and optional color bands for refrigeration services).

The above code indications must be at least at the specified locations for pipe markers and there must always be a code indication next to any banding.

Pipe content names, abbreviations, symbols and numbers must be printed in either black or white, whichever provides the best contrast. The code indications are to be placed directly on the pipe or a label placed on the pipe.

The background color of the label must match the safety identification color.

## BS 1710 - Indicating the Direction of Flow

The direction of the fluid flow in a pipe is to be indicated by an arrow located near the basic identification color. The arrow may be either White or black, whichever provides the best contrast. If a label with the identification color is being used, the direction of flow is indicated by the pointed end of this label.



### 1. Primary Scheme of Identification

#### (Non-Adhesive Pipeline Identification Bands - BS 1710:1984)

Our Non-Adhesive color coded ID band is manufactured in accordance with BS1710:1984, The primary code of identification. The product combines color coding, arrows and services. Its unique design allows the tape to be turned through 360° while text and arrows are still orientated correctly.

The tape is made of durable LDPE material, printed with UV resistant inks with a service temperature range of -40°C to +150°C.

#### Application

Apply the bands at 360° on pipes and secure the ends with double sided fixing tape.

#### 1. Chilled Water Supply (CHWS)

Non-adhesive Identification band available in Size 400 mm X 50 Meter rolls. Wrapped on pipes attached with double sided tape available separately. Complies with BS 1710:1984 & BS4800:1989.

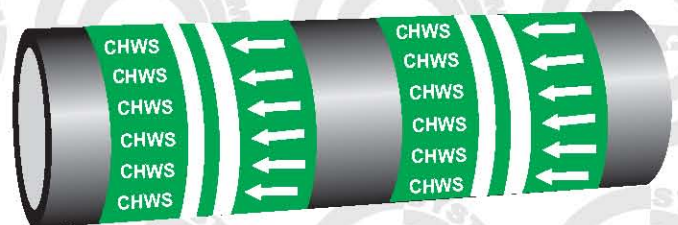
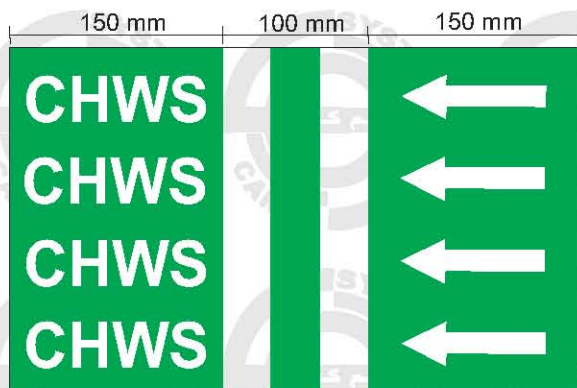

#### 2. Chilled Water Return (CHWR)

Non-adhesive Identification band available in Size 400 mm X 50 Meter rolls. Wrapped on pipes attached with double sided tape available separately. Complies with BS 1710:1984 & BS4800:1989.

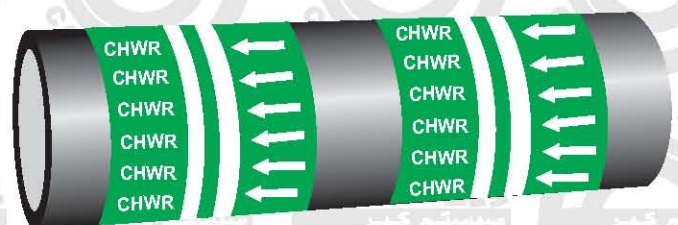
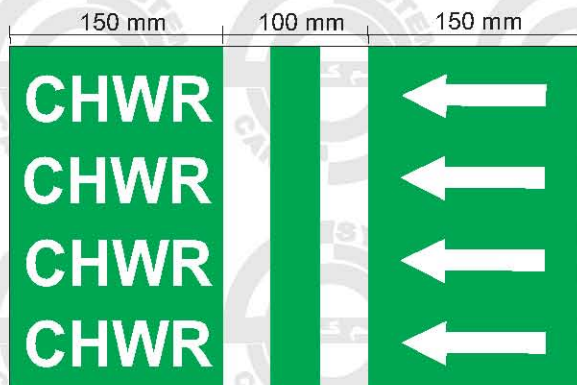

**BS 1710:1984 & BS 4800**

**3. Hot Water Supply (HWS)**

Non-adhesive Identification band available in Size 400 mm X 50 Meter rolls. Wrapped on pipes attached with double sided tape available separately. Complies with BS 1710:1984 & BS4800:1989.

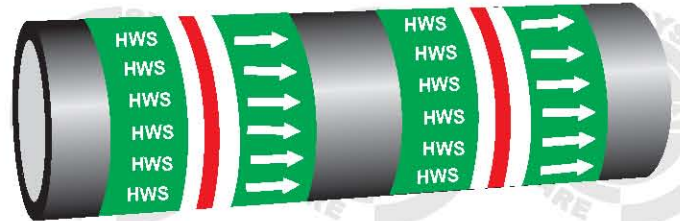
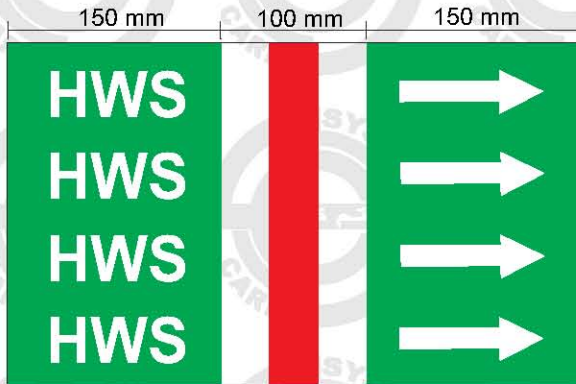

**4. Hot Water Return (HWR)**

Non-adhesive Identification band available in Size 400 mm X 50 Meter rolls. Wrapped on pipes attached with double sided tape available separately. Complies with BS 1710:1984 & BS4800:1989.

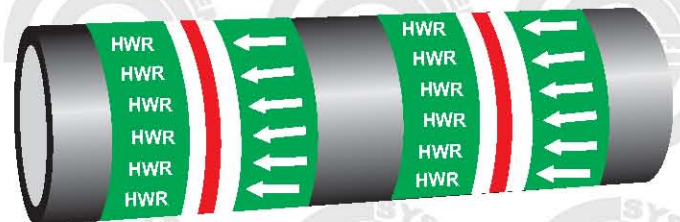
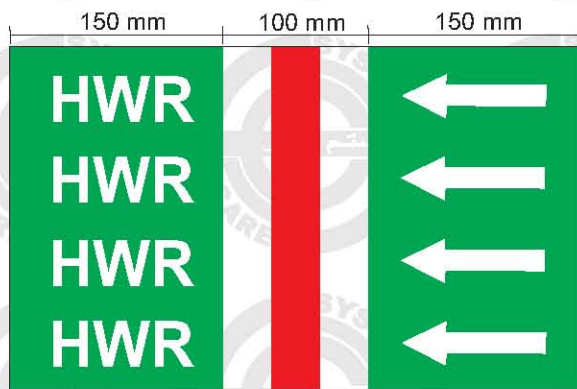

**5. Condensate Drain Water Pipe (CDP)**

Non-adhesive Identification band available in Size 400 mm X 50 Meter rolls. Wrapped on pipes attached with double sided tape available separately. Complies with BS 1710:1984 & BS4800:1989.

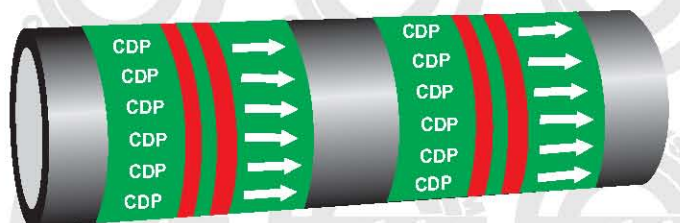
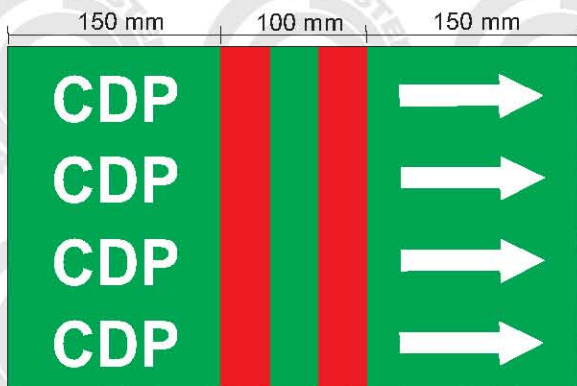



## BS 1710:1984 & BS 4800

### 6. Cold Water Supply-Cold Down Service (CWS)

Non-adhesive Identification band available in Size 400 mm X 50 Meter rolls. Wrapped on pipes attached with double sided tape available separately. Complies with BS 1710:1984 & BS4800:1989.

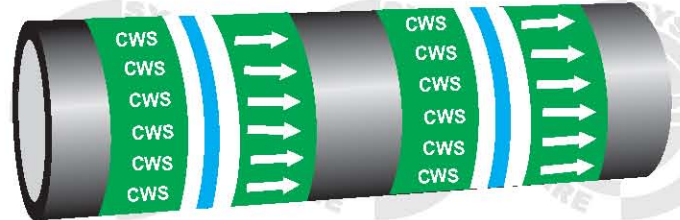
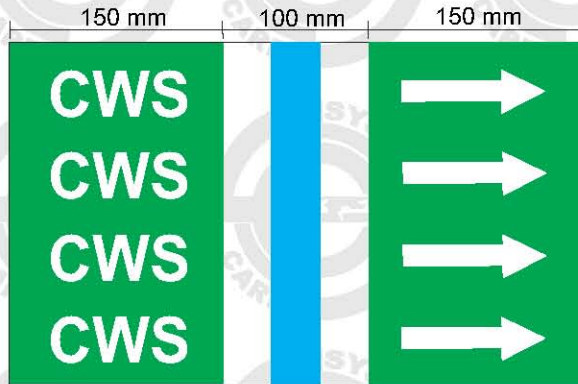

### 7. Fire Fighting - Fire Extinguishing

Non-adhesive Identification band available in Size 400 mm X 50 Meter rolls. Wrapped on pipes attached with double sided tape available separately. Complies with BS 1710:1984 & BS4800:1989.

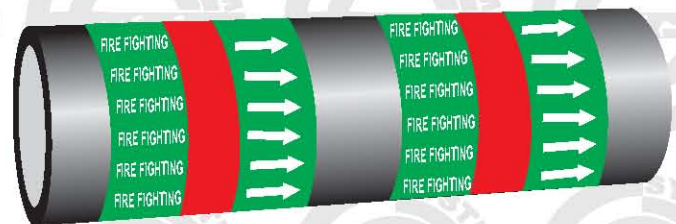
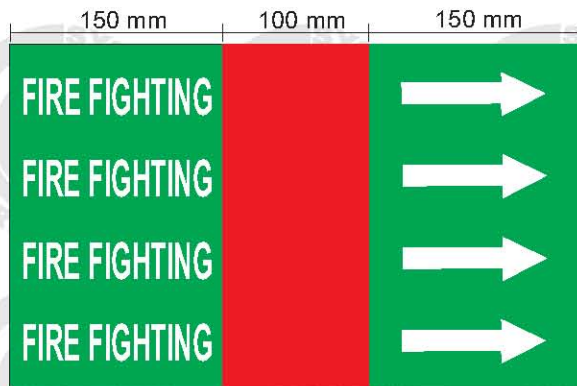

### 8. Sprinkler - Sprinkler Pipe (SPR)

Non-adhesive Identification band available in Size 400 mm X 50 Meter rolls. Wrapped on pipes attached with double sided tape available separately. Complies with BS 1710:1984 & BS4800:1989.

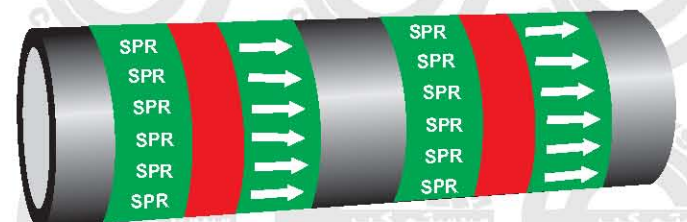
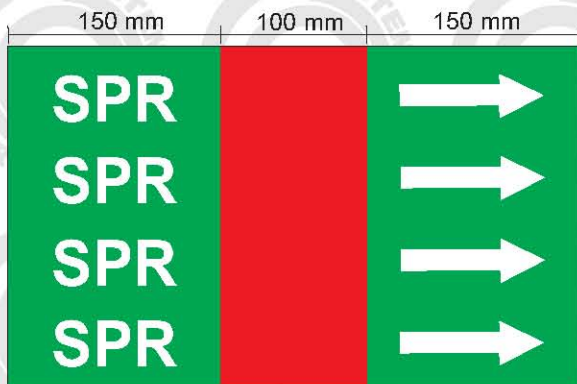

**BS 1710:1984 & BS 4800**

**9. Fire Fighting Service - Wet Riser Pipe**

Non-adhesive Identification band available in Size 400 mm X 50 Meter rolls. Wrapped on pipes attached with double sided tape available separately. Complies with BS 1710:1984 & BS4800:1989.

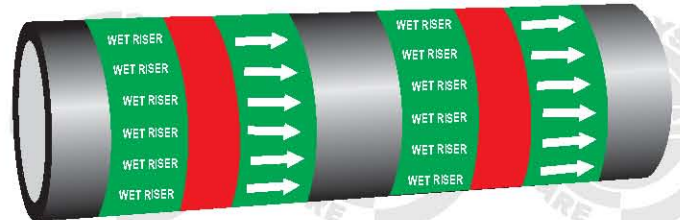
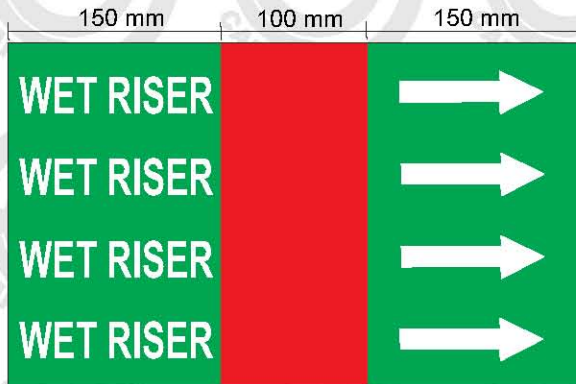

**10. Fire Fighting Service - Dry Riser Pipe**

Non-adhesive Identification band available in Size 400 mm X 50 Meter rolls. Wrapped on pipes attached with double sided tape available separately. Complies with BS 1710:1984 & BS4800:1989.

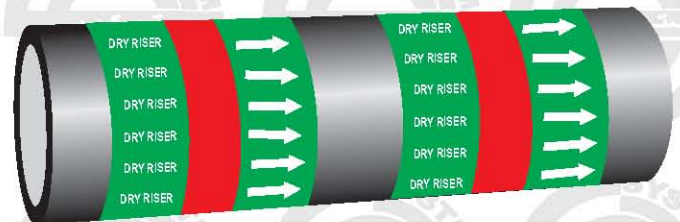
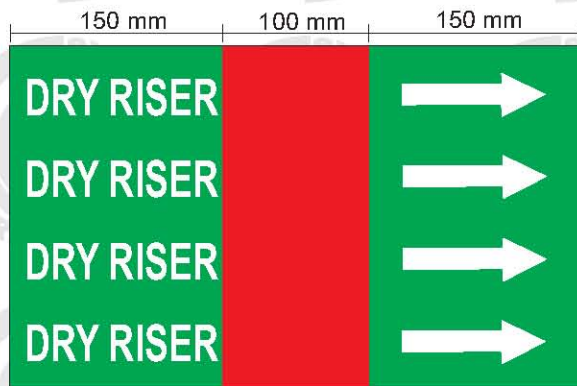

**11. Drainage - Vent Pipe (VP)**

Non-adhesive Identification band available in Size 400 mm X 50 Meter rolls. Wrapped on pipes attached with double sided tape available separately. Complies with BS 1710:1984 & BS4800:1989.

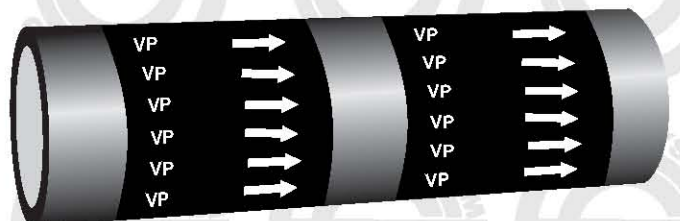
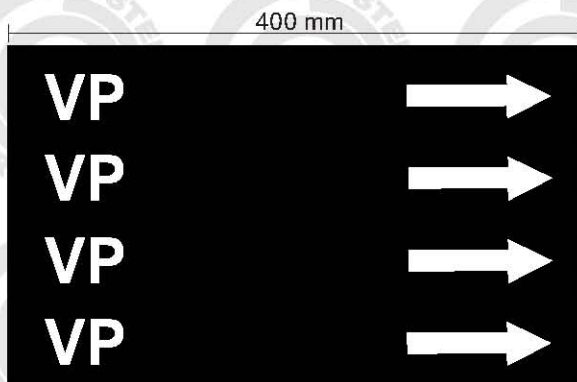



## BS 1710:1984 & BS 4800

### 12. Drainage - Soil Pipe (SP)

Non-adhesive Identification band available in Size 400 mm X 50 Meter rolls. Wrapped on pipes attached with double sided tape available separately. Complies with BS 1710:1984 & BS4800:1989.

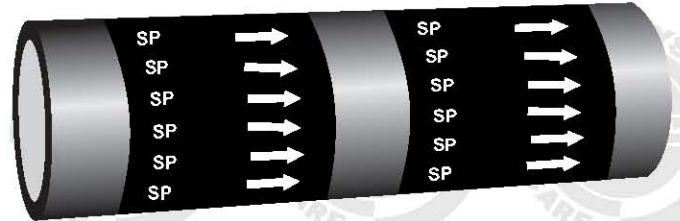

### 13. Drainage - Waste Pipe (WP)

Non-adhesive Identification band available in Size 400 mm X 50 Meter rolls. Wrapped on pipes attached with double sided tape available separately. Complies with BS 1710:1984 & BS4800:1989.

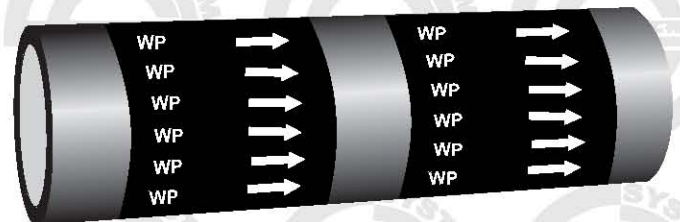
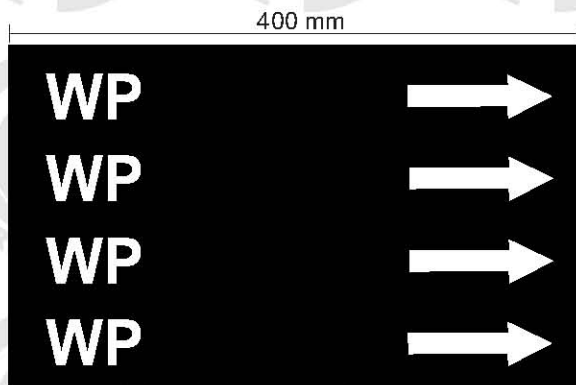

### 14. Drainage - Rain Water Pipe (RWP)

Non-adhesive Identification band available in Size 400 mm X 50 Meter rolls. Wrapped on pipes attached with double sided tape available separately. Complies with BS 1710:1984 & BS4800:1989.

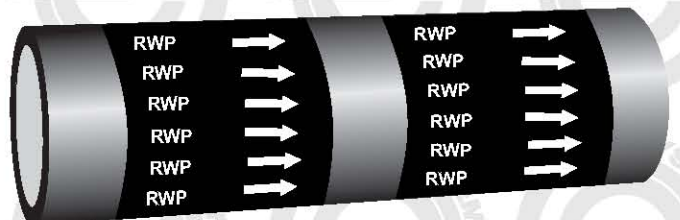



## BS 1710:1984 & BS 4800

### 2. Secondary Scheme of Identification (Self-Adhesive Pipeline Identification Bands - BS 1710:1984)

Our Self-Adhesive color coded ID band is manufactured in accordance with BS1710:1984, the secondary code of identification. Self-adhesive pipe markers are economical and easy tools to mark pipes within a facility. Our self-adhesive pipe markers come in a variety of styles and sizes, featuring wording and arrows, arrows only or wording only. We offer our markers in both label and tape formats to use in any application. Our self-adhesive pipe markers also feature a clear over-laminate shield to protect the message from dirt, grease, grime and harsh conditions.

The tape/label is made of durable high performance calendared PVC film with a gloss/matte surface with a service temperature range of  $-50^{\circ}\text{C}$  to  $+90^{\circ}\text{C}$

#### Application of Tapes

Apply the self-adhesive pipe marking tape at 360° on pipes. Simply peel to release the paper backing from the marker and press the vinyl pipe marker tape in place. Ends should overlap for 25 mm on the blind side of the pipe. It is particularly important that this overlap should be on the blind side where lettering or printed symbols appear on the band.



#### (i) Identification for plumbing service

##### 1. Chilled Water Supply (CHWS)

Self-adhesive identification band available in Size 200 mm X 50 meter, 150 mm X 50 meter, 100 mm X 50 meter, 50 mm X 50 meter rolls. (Custom sizes also available)





## BS 1710:1984 & BS 4800

### 2. Chilled Water Return (CHWR)

Self-adhesive identification band available in Size 200 mm X 50 meter, 150 mm X 50 meter, 100 mm X 50 meter, 50 mm X 50 meter rolls. (Custom sizes also available)

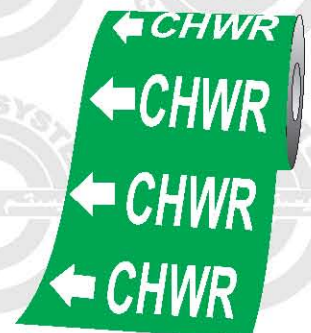
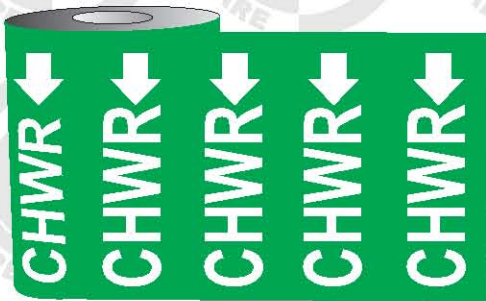

### 3. Hot Water Supply (HWS)

Self-adhesive identification band available in Size 200 mm X 50 meter, 150 mm X 50 meter, 100 mm X 50 meter, 50 mm X 50 meter rolls. (Custom sizes also available)

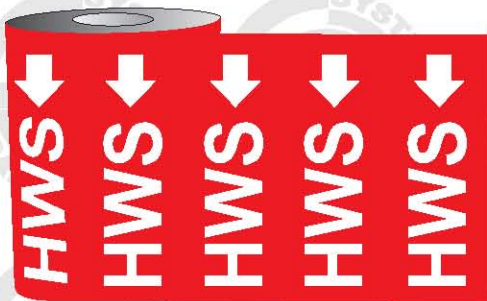

### 4. Hot Water Return (HWR)

Self-adhesive identification band available in Size 200 mm X 50 meter, 150 mm X 50 meter, 100 mm X 50 meter, 50 mm X 50 meter rolls. (Custom sizes also available)

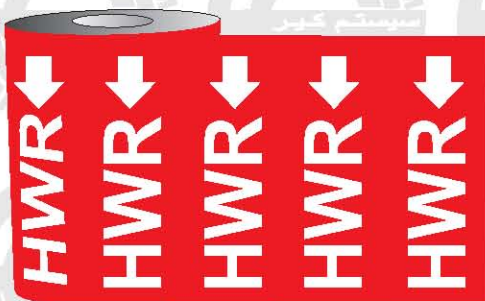

## BS 1710:1984 & BS 4800

### 5. Cold Water Supply - Cold Down Service (CWS)

Self-adhesive identification band available in Size 200 mm X 50 meter, 150 mm X 50 meter, 100 mm X 50 meter, 50 mm X 50 meter rolls. (Custom sizes also available)

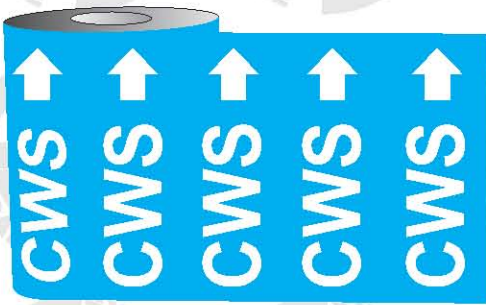

### 6. Drainage - Soil Pipe (SP)

Self-adhesive identification band available in Size 200 mm X 50 meter, 150 mm X 50 meter, 100 mm X 50 meter, 50 mm X 50 meter rolls. (Custom sizes also available)

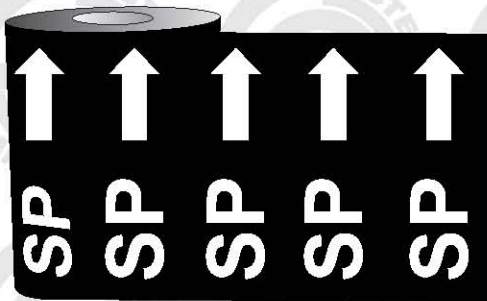

### 7. Drainage - Waste Pipe (WP)

Self-adhesive identification band available in Size 200 mm X 50 meter, 150 mm X 50 meter, 100 mm X 50 meter, 50 mm X 50 meter rolls. (Custom sizes also available)

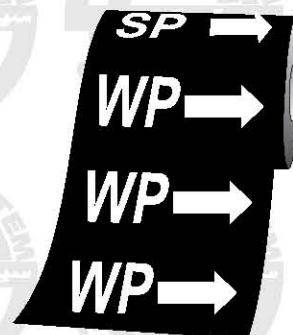
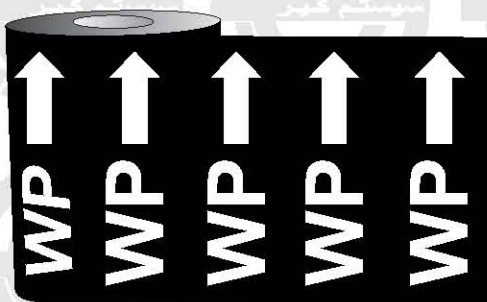



## BS 1710:1984 & BS 4800

### 8. Drainage - Rain Water Pipe (RWP)

Self-adhesive identification band available in Size 200 mm X 50 meter, 150 mm X 50 meter, 100 mm X 50 meter, 50 mm X 50 meter rolls. (Custom sizes also available)

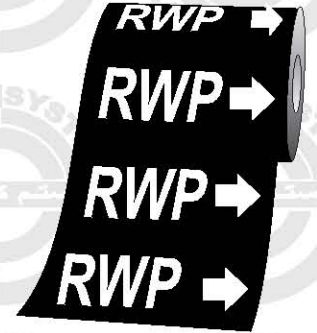
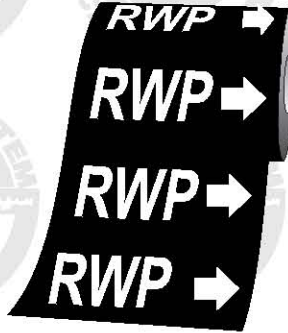
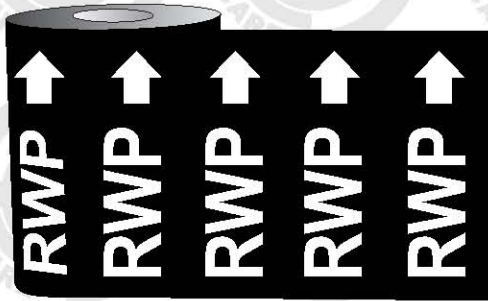

### 9. Drainage - Vent Pipe (VP)

Self-adhesive identification band available in Size 200 mm X 50 meter, 150 mm X 50 meter, 100 mm X 50 meter, 50 mm X 50 meter rolls. (Custom sizes also available)

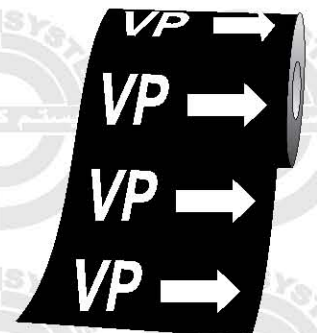
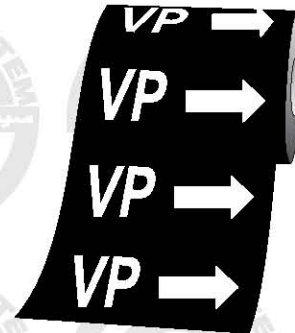
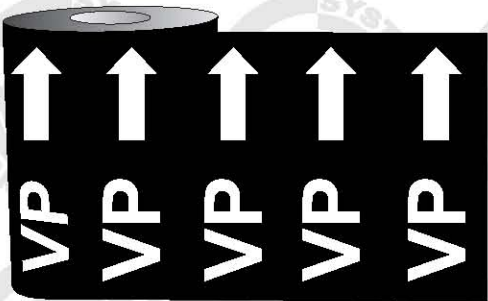

### 10. Condensate Drain Water Pipe (CDP)

Self-adhesive identification band available in Size 200 mm X 50 meter, 150 mm X 50 meter, 100 mm X 50 meter, 50 mm X 50 meter rolls. (Custom sizes also available)

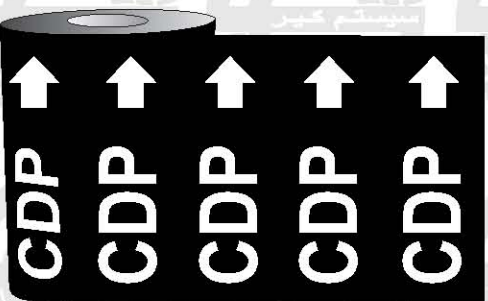

## BS 1710:1984 & BS 4800

### (ii) Identification for fire Fighting Service

#### 1. Fire Fighting

Self-adhesive identification band available in Size 200 mm X 50 meter, 150 mm X 50 meter, 100 mm X 50 meter, 50 mm X 50 meter rolls. (Custom sizes also available)



#### 2. Fire Fighting Service - Sprinkler Pipe

Self-adhesive identification band available in Size 200 mm X 50 meter, 150 mm X 50 meter, 100 mm X 50 meter, 50 mm X 50 meter rolls. (Custom sizes also available)

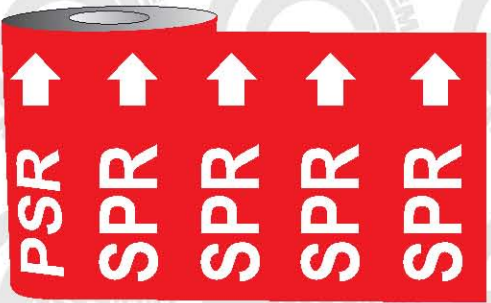

#### 3. Fire Fighting Service - Wet Riser Pipe

Self-adhesive identification band available in Size 200 mm X 50 meter, 150 mm X 50 meter, 100 mm X 50 meter, 50 mm X 50 meter rolls. (Custom sizes also available)

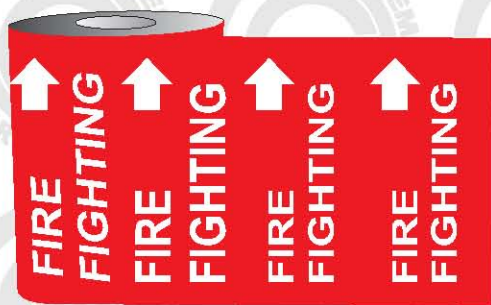



## BS 1710:1984 & BS 4800

### 4. Fire Fighting Service - Dry Riser Pipe

Self-adhesive identification band available in Size 200 mm X 50 meter, 150 mm X 50 meter, 100 mm X 50 meter, 50 mm X 50 meter rolls. (Custom sizes also available)



### 5. Fire Fighting Service - Fire Water Line

Self-adhesive identification band available in Size 200 mm X 50 meter, 150 mm X 50 meter, 100 mm X 50 meter, 50 mm X 50 meter rolls. (Custom sizes also available)

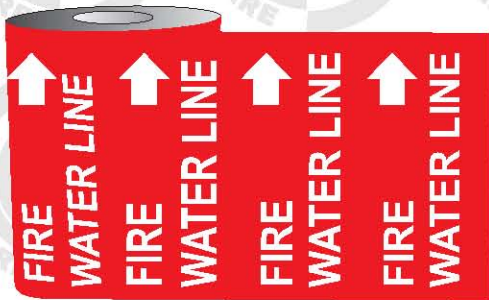

### Fire Fighting Service - Strip



Available sizes as per standard  
400 mm X 50 mm, 300 mm X 50 mm, 200 mm X 25 mm.  
Custom sizes also available.



## BS 1710:1984 & BS 4800

### Identification Label as per BS - 1710 Self Adhesive Strips

Pipe markers are a practical, economical marking system featuring characters printed on bright BS conforming colors to provide unmistakable identification of pipe contents. Our pipe markers are manufactured with acrylic adhesive. Available in standard sizes of 400 mm X 50 mm & 300 mm X 50 mm. Color schemes and letter height all meet British standard scheme for the identification of piping systems.

#### Application of Labels

Apply the self-sticking pipe marking directly on pipes. Simply peel to release the paper backing from the marker and press the vinyl pipe marker tape in place.

<b>HOT WATER SUPPLY</b> →	خط امداد مياه مبرده
<b>HOT WATER RETURN</b> ←	<b>CHILLED WATER SUPPLY</b>
<b>CHILLED WATER SUPPLY</b> →	خط راجع مياه مبرده
<b>CHILLED WATER RETURN</b> ←	<b>CHILLED WATER RETURN</b>
<b>COLD WATER SUPPLY</b> →	مياه صالحة للشرب
<b>COLD WATER RETURN</b> ←	<b>POTABLE WATER</b>
<b>WASTE PIPE</b> →	أنابيب النفايات السائلة →
<b>VENT PIPE</b> →	أنابيب التهوية →
<b>SOIL PIPE</b> →	أنابيب النفايات الصلبة →
<b>RAIN WATER PIPE</b> →	<b>CONDENSATE DRAIN PIPE</b> →

Available sizes as per standard  
400 mm X 50 mm, 300 mm X 50 mm, 200 mm X 25 mm.  
Custom sizes also available.



## BS 1710:1984 & BS 4800

### 3. Color Coded Banding Tapes (BS 1710:1984)

Color coded banding tapes are printed to current British Standards 1710:1984 with amendments 1989 and 1991 and to BS 4800 color specifications or continental RAL standards.

These tapes are used to indicate the basic nature of the pipe content. These tapes can be used in conjunction with basic identification tapes. They are of importance where the exact nature of the pipe content needs to be clearly identified.

#### STANDARD COLORS



## ASME/ANSI A13.3-1981 & 2007

# Pipe Marking & Identification According to ASME/ANSI A13.1-1981 & 2007

### ASME/ANSI Standard

ANSI/ASME A13.1 is the most common pipe identification standard used in the United States and until the latest revision dated 2007 the standard has been unchanged for nearly half a century. The standard specifies the primary and secondary means of identifying pipe content, as well as the size, color and placement of the identification device.

According to ANSI/ASME A13.1, pipe markers should conform to certain requirements. The most recent update to the ANSI/ASME A13.1 code was the introduction of a new color scheme that specifies which colors to use for pipe labels. The code also specifies standards for label sizes and placement.

In 2007 the ANSI/ASME A13.1 standard was updated and is now recommended for all new pipe marker applications. For facilities with existing pipe markers, it is recommended that they are updated for consistent identification.

### ANSI/ASME A13.1 Standard Label Colors

The current version of the ANSI/ASME code uses a pipe labeling standard color code chart with six standard color combinations and four user-defined combinations as shown in the table below. The colors are based on the contents of the pipe. In general, the most hazardous feature of the contents should determine the colors used.

Pipe Contents	Color Scheme
Fire-quenching fluids	White Text on Red
Toxic and corrosive fluids	Black Text on Orange
Flammable fluids	Black Text on Yellow
Combustible fluids	White Text on Brown
Potable, cooling, boiler feed, and other water	White Text on Green
Compressed air	White Text on Blue
User-defined	White Text on Purple
User-defined	Black Text on White
User-defined	Black Text on Grey
User-defined	White Text on Black



### ANSI/ASME Color code Comparison

#### ANSI/ASME A13.1 1996 Color Scheme:

<b>Materials Inherently Hazardous</b> <ul style="list-style-type: none"> <li>• Flammable or Explosive</li> <li>• Chemical Active or Toxic</li> <li>• Extreme Temperature or Pressures</li> <li>• Radioactive</li> </ul>	<b>Materials of Inherently Low Hazard</b> <ul style="list-style-type: none"> <li>• Liquid or Liquid Admixture (ono-hazardous materials)</li> </ul>	<b>Materials of Inherently Low Hazard</b> <ul style="list-style-type: none"> <li>• Gas or Gaseous Admixture (ono-hazardous materials)</li> </ul>	<b>Fire Quenching Materials</b> <ul style="list-style-type: none"> <li>• Water, Foam, Co2, Halon, etc. (sprinkler systems or fire protection equipment)</li> </ul>
Yellow Bkgd - Black Legend	Green Bkgd - White Legend	Blue Bkgd - White Legend	Red Bkgd - White Legend

#### Application

Pipe labels should be positioned so that they can be easily seen from the normal angle of approach. For instance, below the centerline of the pipe if the pipe is overhead and above the centerline if the pipe is below eye level. Pipe labels should be placed:

- (a) Adjacent to all valves and flanges.
- (b) Adjacent to all changes of direction.
- (c) On both sides of wall or floor penetrations.
- (d) At regular intervals on straight runs (50 feet is the acceptable maximum spacing, but closer spacing might be necessary for visibility).

### 1. Primary Scheme of Identification

The legend (name of the pipe content) and directional flow arrow remain the primary means of identifying pipe content. The size and placement of the marker and arrow has not changed.

For pipes with O.D. of 3/4" to 1-1/4" (19 to 32 mm) Legend Size: 1 1/2" (13 mm) high Marker Size: 8" (200 mm) wide	For pipes with O.D. of 1-1/2" to 2-3/8" (38 to 60 mm) Legend Size: 3 1/4" (19 mm) high Marker Size: 8" (200 mm) wide
For pipes with O.D. of 2-1/2" to 7-7/8" (64 to 150 mm) Legend Size: 1-1 1/4" (32 mm) high Marker Size: 14" (355 mm) wide	For pipes with O.D. of 8" to 10" (200 to 250 mm) Legend Size: 2-1 1/2" (64 mm) high Marker Size: 24" (600 mm) wide
For pipes with O.D. over 10" (250 mm) Legend Size: 3-1 1/2" (89 mm) high Marker Size: 32" (800 mm) wide	

Pipe diameter determines the appropriate label and text sizes, as shown in the following table.

Outside Pipe Diameter (Including insulation)		Minimum Length of Label Color Field		Minimum Letter Height		Minimum Characters
Inches	mm	Inches	mm	Inches	mm	
0.75-1.25	19-32	8	203	0.5	13	22
1.5-2	38-51	8	203	0.75	19	18
2.5-6	64-152	12	305	1.25	32	22
8-10	203-254	24	610	2.5	64	22
>10	>254	32	813	3.5	89	22



# ASME/ANSI A13.3-1981 & 2007

## 2. Secondary Scheme of Identification

The secondary means of identification is the color code of the marker. That portion of the standard has changed dramatically. In addition, the terminology of inherently hazardous or non hazardous has been removed from the standard. The most obvious change is the color code assign- most of two of most widely used color combinations of yellow / Black and green / White. The combination of Yellow / Black is now assigned with flammable fluids and Green / White shall now identify potable, cooling, boiler feed and other waters. These two changes mean that legends such as hot water, cold water and steam will now all use the color code of Green / White.

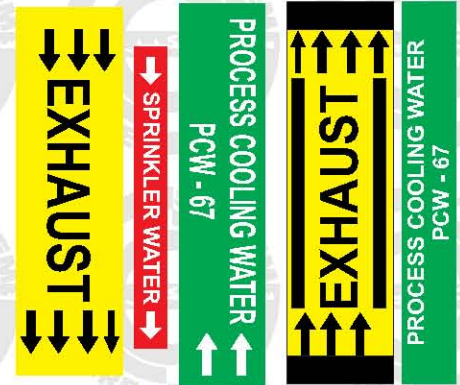

The other significant color changes include the addition of Brown / White for combustible fluids and Orange/Black for toxic and corrosive fluids. The fact that the standards have identified specific colors for flammable fluids, combustible fluids and toxic or corrosive fluids means that our customers must consult material safety data sheets before selecting a color. Further, if the pipe contains multiple hazards (flammable and toxic) it must be determined which poses the greatest risk. In another example, if chilled or heating water systems contain a toxic treatment the color combination should be Orange/Black. The new 2007 standard also for the first time identifies four additional user defined color combinations and specifically identifies all of the actual colors to be used. The exact colors are contained in the ANSI Z535.1-2007 standard.



## Self adhesive pipeline identification as per ANSI/ASME A 13.1 1996

### 1. CHILLED WATER SUPPLY

Self-adhesive identification labels available in Size : 400 mm X 50 mm, 300 mm X 50 mm.  
 Self-adhesive identification labels available in Size : 50 mm X 50 meter rolls.  
 Custom Sizes also available.



400 mm / 300 mm

50 mm

CHILLED WATER SUPPLY

50 mm

50 meter



### 2. CHILLED WATER RETURN

Self-adhesive identification labels available in Size : 400 mm X 50 mm, 300 mm X 50 mm.  
Self-adhesive identification labels available in Size : 50 mm X 50 meter rolls.  
Custom Sizes also available.

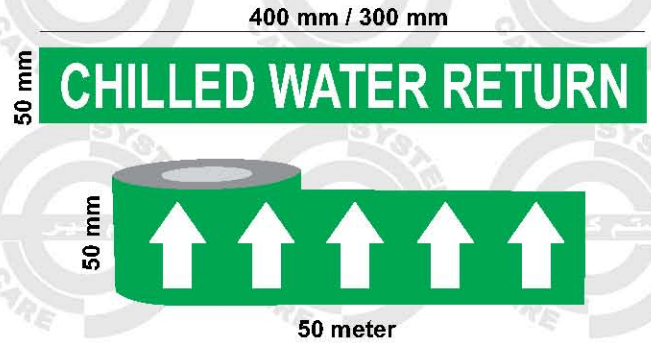

### 3. CONDENSER WATER SUPPLY

Self-adhesive identification labels available in Size : 400 mm X 50 mm, 300 mm X 50 mm.  
Self-adhesive identification labels available in Size : 50 mm X 50 meter rolls.  
Custom Sizes also available.

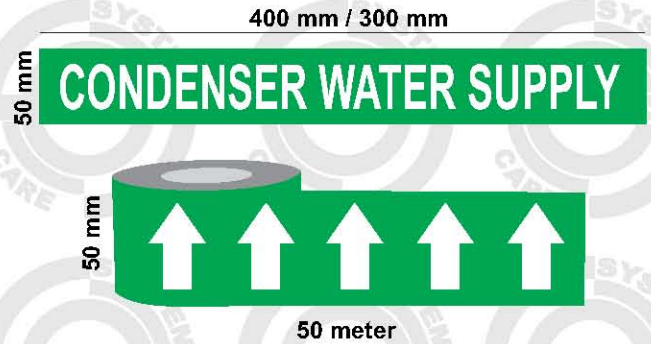

### 4. CONDENSER WATER RETURN

Self-adhesive identification labels available in Size : 400 mm X 50 mm, 300 mm X 50 mm.  
Self-adhesive identification labels available in Size : 50 mm X 50 meter rolls.  
Custom Sizes also available.

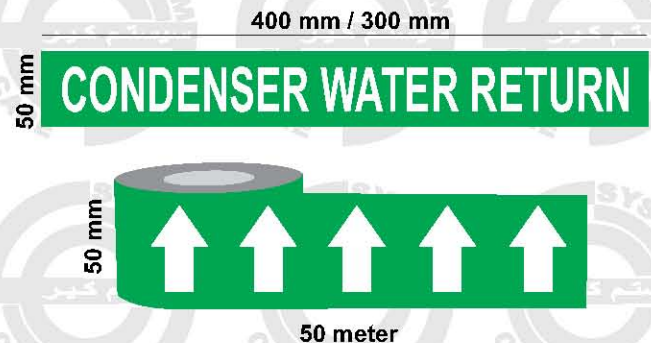

**ASME/ANSI A13.3-1981 & 2007**

**5. DOMESTIC HOT WATER**

Self-adhesive identification labels available in Size : 400 mm X 50 mm, 300 mm X 50 mm.  
 Self-adhesive identification labels available in Size : 50 mm X 50 meter rolls.  
 Custom Sizes also available.

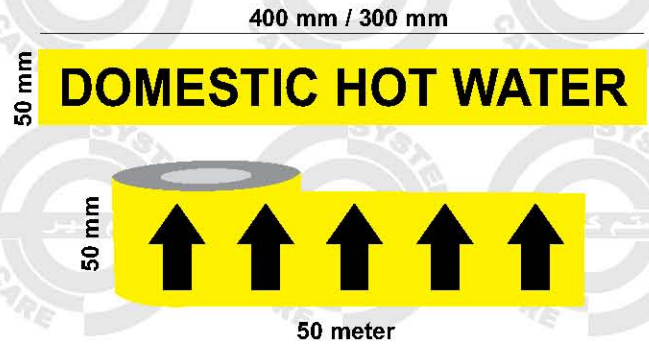

**6. HIGH PRESSURE WATER**

Self-adhesive identification labels available in Size : 400 mm X 50 mm, 300 mm X 50 mm.  
 Self-adhesive identification labels available in Size : 50 mm X 50 meter rolls.  
 Custom Sizes also available.

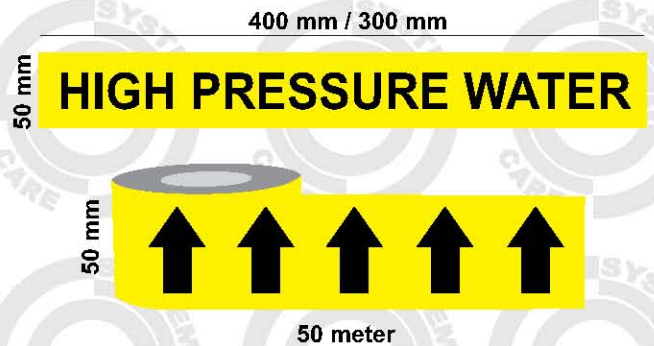

**7. COLD WATER SUPPLY**

Self-adhesive identification labels available in Size : 400 mm X 50 mm, 300 mm X 50 mm.  
 Self-adhesive identification labels available in Size : 50 mm X 50 meter rolls.  
 Custom Sizes also available.

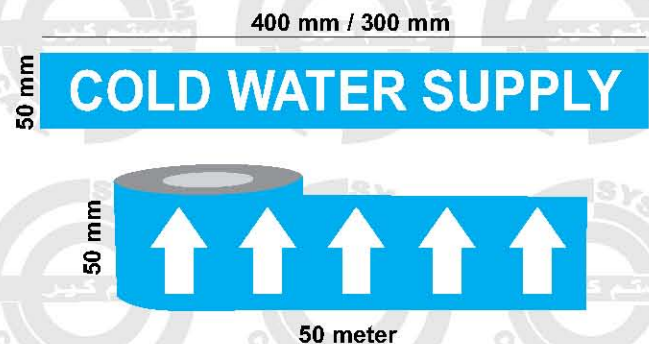



### 5. SPRINKLER WATER

Self-adhesive identification labels available in Size : 400 mm X 50 mm, 300 mm X 50 mm.  
Self-adhesive identification labels available in Size : 50 mm X 50 meter rolls.  
Custom Sizes also available.



400 mm / 300 mm



50 meter

### 6. FIRE PROTECTION WATER

Self-adhesive identification labels available in Size : 400 mm X 50 mm, 300 mm X 50 mm.  
Self-adhesive identification labels available in Size : 50 mm X 50 meter rolls.  
Custom Sizes also available.



400 mm / 300 mm



50 meter

### 7. HOT WATER SUPPLY

Self-adhesive identification labels available in Size : 400 mm X 50 mm, 300 mm X 50 mm.  
Self-adhesive identification labels available in Size : 50 mm X 50 meter rolls.  
Custom Sizes also available.



400 mm / 300 mm



50 meter

**BS 1710 / BS 4800**

**Duct Marking (DW 144 Standard Supported)**

With the increasing complexity of ventilation and air conditioning systems it is becoming more important to ensure ready identification of ducts for the purpose of commissioning, operation and maintenance of systems. The purpose of these recommendations is to lead towards the use and standardization of a system of identification for ducts for the benefit of designers, contractors and clients.

**Duct Identification Labels as per BS 1710/BS 4800**

With reference to DW-144 Appendix B, the recommended duct identification colors as per BS 1710 supported by BS 4800 are :-

Type	Colour	BS 4800
1	2	3
Conditioned air	Red and Blue	04 E 53 18 E 53
Warm air	Yellow	10 E 53
Fresh air	Green	14 E 53
Exhaust/Extract/ reticulated air	Grey	00 A 09
Foul air	Brown	06 C 39
Dual duct system- hot supply air	Red	04 E 53
Dual duct system- cold supply air	Blue	18 E 53

**Example of duct identification symbol**





### Application

Several methods are available for applying the symbols. The main factor being that the symbol is permanently affixed. Suitable methods are:

1. Painting, using stenciled letters and figures.
2. Self-Adhesive plastics or transfers with water soluble backing. (It is important to ensure that the surface is smooth and clean and that the adhesion will not deteriorate due to the surrounding atmosphere)

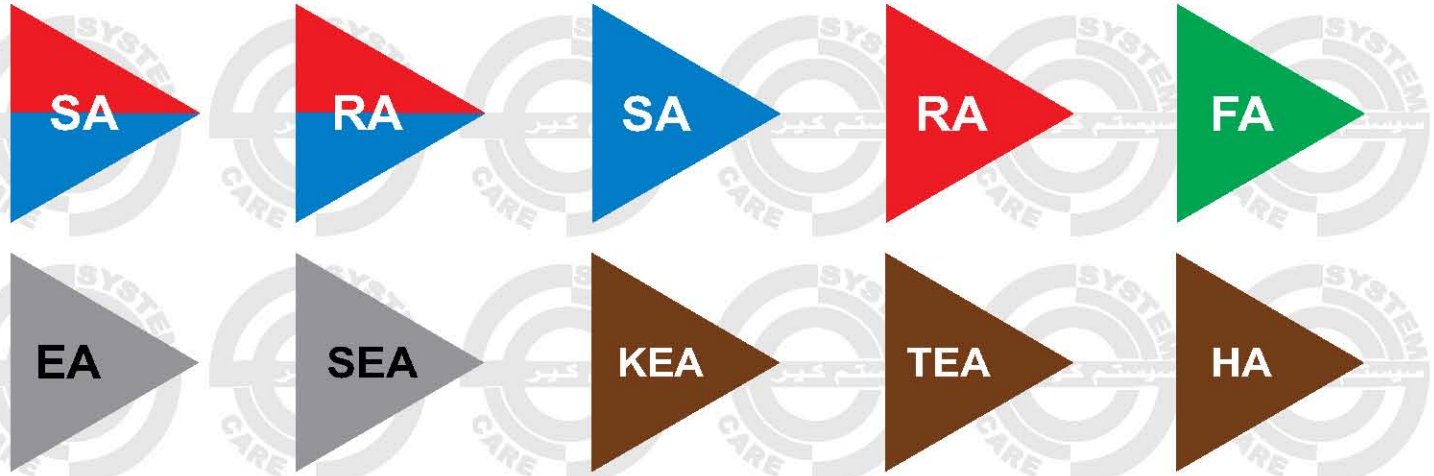

## ANSI / ASME

### Duct Identification Labels as per ANSI/ASME

The accepted standard for duct labeling is based on the ASME A13.1 labeling system. The label consists of a legend describing the contents of the duct, a directional arrow indicating air flow and a color coded background indicating physical properties of the air. The three colors used are: Green (cold air supply & exhaust): Yellow (warm air supply & exhaust): Blue (mixed air supply & exhaust).

#### MARKER SIZE, LETTER HEIGHT & MAX. CHARACTERS PER MARKER CHART

The following chart shows the recommended pipe marker letter height and marker size based on 24" ducts.

For ducts up to 24"		For ducts 24" and over	
Legend Size:	1-1/2" High	Legend Size:	2-1/2" High
Marker Size:	2-1/4"x 13-1/2"	Marker Size:	4"x 20"
Arrow Size:	2-1/4"x 2-1/2"	Arrow Size:	4"x 4"

Duct Size	Text Size	Marker Style	Max. Characters
up to 24"	1-1/2"	DMS	22
24" & over	2-2/1"	DML	18

# ANSI / ASME

## Application

Install duct markers in clear view and try to align with the axis of the duct. Install duct markers at a minimum distance of 20 feet and a maximum of 50 feet on exposed horizontal and vertical runs in each space where duct work is exposed, or concealed, only by removable ceiling and near points where duct work originates or continues into concealed enclosures (shaft, underground, etc.). Provide duct markers on each access door in duct work and housings indicating purpose of access, where access doors are concealed above acoustical ceilings or similar concealment.

## Duct Identification Labels as per Dw144 supported by ANSI/ASME color codes.



## Duct Identification Labels as per ANSI / ASME color codes.

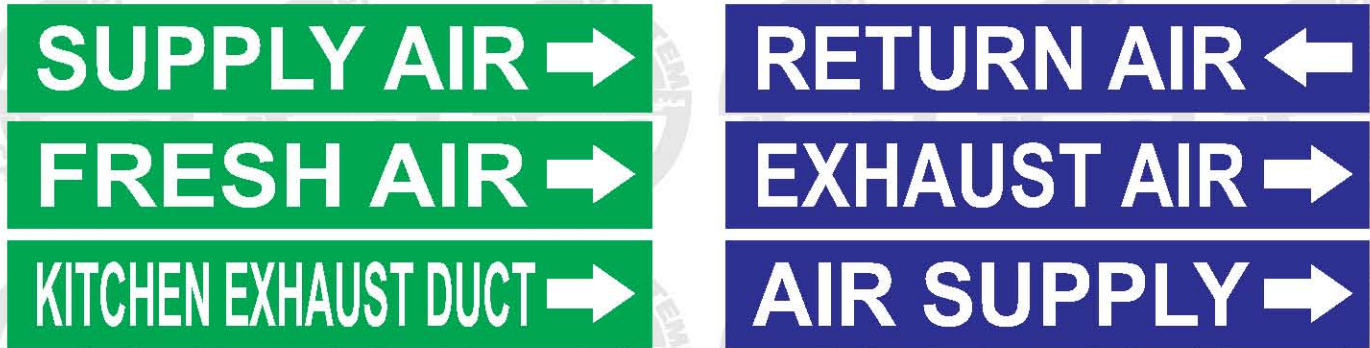

## AIR SUPPLY

Self-adhesive identification labels available in Size : 400 mm X 50 mm, 300 mm X 50 mm.  
 Self-adhesive identification labels available in Size : 50 mm X 50 meter rolls.  
 Custom Sizes also available.

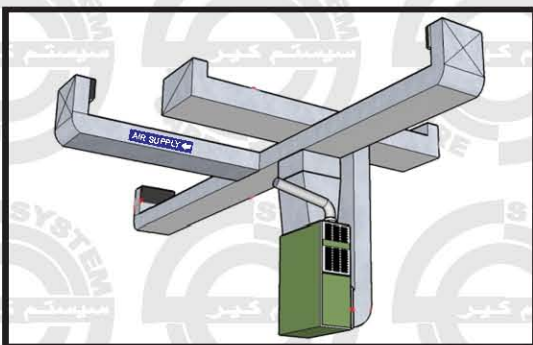

400 mm / 300 mm



### EXHAUST AIR

Self-adhesive identification labels available in Size : 400 mm X 50 mm, 300 mm X 50 mm.  
Self-adhesive identification labels available in Size : 50 mm X 50 meter rolls.  
Custom Sizes also available.

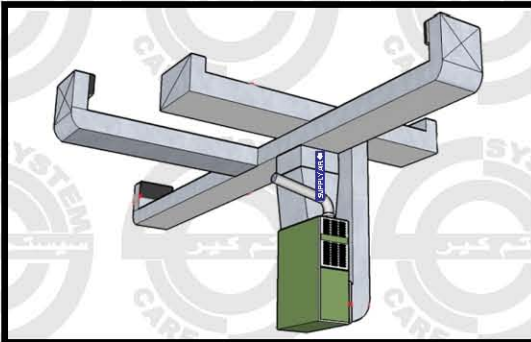

400 mm / 300 mm

50 mm

**EXHAUST AIR →**

**EXHAUST AIR ←**

### SUPPLY AIR

Self-adhesive identification labels available in Size : 400 mm X 50 mm, 300 mm X 50 mm.  
Self-adhesive identification labels available in Size : 50 mm X 50 meter rolls.  
Custom Sizes also available.

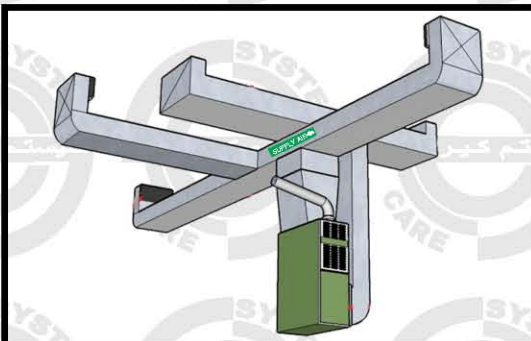

400 mm / 300 mm

50 mm

**SUPPLY AIR →**

**SUPPLY AIR ←**

### FRESH AIR

Self-adhesive identification labels available in Size : 400 mm X 50 mm, 300 mm X 50 mm.  
Self-adhesive identification labels available in Size : 50 mm X 50 meter rolls.  
Custom Sizes also available.

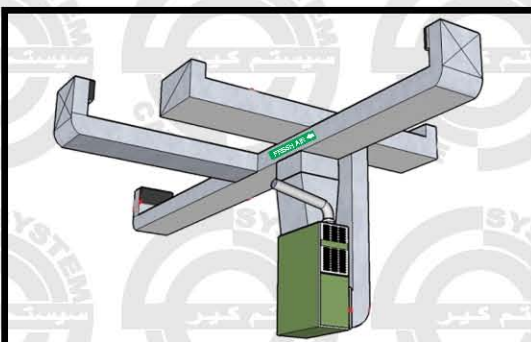

400 mm / 300 mm

50 mm

**FRESH AIR →**

**FRESH AIR ←**

**Identification Label/Marker for Conduits,  
Cable Raceways, Trays & Trunking**

Identification Label/Marker for Conduits, Cable Raceways, Trays & Trunking as per  
BS 1710:1984 & BS 4800

**ACCESS CONTROL****EMERGENCY LIGHTING 220V****LOW CURRENT****POWER CABLE 380V****ELECTRICAL POWER****ELV CONTAINMENT****LIGHTING/POWER 440V****CONTROL CABLES****LIGHTING AND POWER CIRCUITS-230V****BMS CONTAINMENT**

Identification Label/Marker for Conduits, Cable Raceways, Trays & Trunking as per  
ASME/ANSI A13.1-1981 & 2007

**CLEAN EARTHING CABLES****POWER CABLES****GSM CABLES****230V POWER CIRCUITS****STRUCTURED CABLING SYSTEM****230V LIGHTING CIRCUITS****UPS POWER CIRCUITS****BMS CABLES****FIRE ALARM CABLES****CCTV CABLES**



## Polyethylene Warning Tapes

This is the most economical way of warning excavators of buried services below ground. The tape can be printed with any text in any language, any color and any size, manufactured to specifications. Standard texts are available ex-stock.

The PE warning tapes & boards ensure that excavating crews are warned of the presence of electric cables, water pipelines, telecommunication cables and other service lines.

The PE warning tapes & boards are made from polyethylene sheet and are suitable for use in all soil conditions. Their bright unfading coloration and clear printing with warning and identification text make them efficient warning markers.



### FEATURES

- Material - High quality linear low density, lead free, virgin. grade polyethylene for toughness and long life.
- Excellent chemical resistance.
- Available in Red, Yellow, Blue or White standard colors. Depends on the application.
- Supplied in rolls which are easy to handle and lay.
- Elongation: Machine direction 400% transverse direction 500%
- Tensile strength - 15 N/mm<sup>2</sup> (Based on 100 micron thickness material)
- Soil Tolerance pH 2.5 - pH 11.0.
- Manufactured in accordance with ESI 12-13.
- Various thickness of polyethylene available.



### POLYETHYLENE WARNING TAPE SIZES

Width	Thickness	Roll Length
150 mm	100 / 150 microns	250 or 500 Mtrs
250 mm	100 / 150 microns	250 or 500 Mtrs
400 mm	100 / 150 microns	250 or 500 Mtrs

### MATERIAL PROPERTIES

PROPERTY	TEST METHOD	UNITS	VALUE
Density	.....	Kg/m <sup>3</sup>	0.920
Tensile Strength	ASTM D 882	N/mm <sup>2</sup>	15
Elongation at break	ASTM D 882	%	350

### Important Note

All values shown are averages and should not be used for specification purposes.

Test data and test results contained in this document are for general information and it may vary from test to another.



# Detectable Warning Tapes

## DETECTABLE METAL BACKED WARNING TAPES (A COLORED PLASTIC COATED STRIP OF ALUMINUM FOIL TAPE)

The detectable warning tape ensures that excavation crews are warned of the presence of Water pipelines, Telecommunication Cables, Sewer Mains & Irrigation pressure mains.

The detectable warning tape contains incorporated aluminum foil so that it can be detected from the ground surface. The detectable warning tapes are suitable for use in all soil conditions. Their bright unfading coloration and clear printing with warning and identification text make them efficient warning markers.

### FEATURES

- Not less than 99.5% purity aluminum foil.
- Tensile strength 150 kg/cm<sup>2</sup>.
- Cost effective.
- Bonded between a layer of PET and a layer of polyethylene to prevent corrosion.
- Continuous metallic tracer element.



Width	Thickness	Roll Length
150 mm	150 / 250 microns	250 Mtrs
250 mm	150 / 250 microns	250 Mtrs
300 mm	150 / 250 microns	250 Mtrs
300 mm	500 microns	250 Mtrs

Product Description: Detectable underground warning tape  
PE/AL FOIL/PET

Standard size : 150 mm x 250 meter x 150 micron

Length - 250 meter

Thickness : 150 micron (+10%)

Color : 150 micron (+10%)

Printed Message : Reverse printed in Arabic & English  
Text as per customer specification

### Physical Properties

- Tensile Strength : MD - 25 N/mm<sup>2</sup>  
TD - 23 N/mm<sup>2</sup>
- Elongation : MD - 400% (PE only)  
TD - 500% (PE only)
- Tear Strength : MD - 220 gf  
TD - 260 gf
- Dart Impact : 500 g

### Chemical Resistance

- Water : No effect
- Alcohol mix : No effect
- Oil : No effect
- 5% Acetic acid : No effect
- 5% Na OH : No effect

- Printing will remain unaffected in all conditions.
- Tapes are resistant to environmental stress.
- Tapes exhibit good resistance to minerals in sub-soil and various chemicals.





## MATERIAL SPECIFICATIONS AND TECHNICAL PROPERTIES FOR DETECTABLE METAL BACKED WARNING TAPES BASED ON SPECIMEN WIDTH 25 MM & 250 MICRONS THICK

Property	Test Method	Units	Value	
			Max.	Min
Tensile strength Load (longitudinal) On specimen width 25 mm x 250 microns thick	BS EN ISO 527-3:1996 BS 2782-3-326E:1966	N	178	160
Tensile strength Load (transverse) On specimen width 25 mm x 250 microns thick	BS EN ISO 527-3:1996 BS 2782-3-326E:1966	N	162	150
Elongation (longitudinal) On specimen width 25 mm x 250 microns thick	BS EN ISO 527-3:1996 BS 2782-3-326E:1966	%	480	450
Elongation (transverse) On specimen width 25 mm x 250 microns thick	BS EN ISO 527-3:1996 BS 2782-3-326E:1966	%	560	550
Tear strength Load (longitudinal) On specimen width 25 mm x 250 microns thick	BS 2782 Part 3,360B 1991 BS 2782 Part 3,360A 1991	gf	670	640
Tear strength Load (transverse) On specimen width 25 mm x 250 microns thick	BS 2782 Part 3,360B 1991 BS 2782 Part 3,360A 1991	gf	765	700
Part impact free falling On specimen width 25 mm x 250 microns thick	BS 2782 Part 3,352E 1996 BS 2782 Part 3,352F 1996	g	1420	1000

- The above mentioned values are for tape thickness of 250 microns
- Tape can be tested in accordance with any standard for methods of testing plastic film & sheeting
- Other applicable standards : A.STM, BS, ISO and AS/NZS.

## MATERIAL SPECIFICATIONS AND TECHNICAL PROPERTIES FOR DETECTABLE METAL BACKED WARNING TAPES BASED ON SPECIMEN OF 100 TO 200 MICRONS THICK

### MATERIAL SPECIFICATIONS AND TECHNICAL PROPERTIES

Property	Test Method	Units	Value Minimum
Test strength (longitudinal)	BS EN ISO 527-3:1996	Kg/cm <sup>2</sup>	125
Tensile strength (transverse)	BS EN ISO 527-3:1996	Kg/cm <sup>2</sup>	105
Elongation (longitudinal)	BS EN ISO 527-3:1996	%	350
Elongation (transverse)	BS EN ISO 527-3:1996	%	350

Colors: Yellow, Blue, Orange and Green

### Important Note

All values shown are averages and should not be used for specification purposes.

Test data and test results contained in this document are for general information and it may vary from otest to another.



# Polyethylene Cable Tiles

## PROTECTION COVER TILES (PE)



The polyethylene cable cover constitutes a cable warning, protection and marker system for use in all ground conditions. Being extremely tough and long lasting, they offer ideal protection to all underground services. Each tile is supplied with a peg, allowing for strong longitudinal joining for un-interrupted protection, unlike concrete tiles.

The polyethylene tiles are extremely tough and do not tend to crack. They comply with impact strength requirements for concrete tiles to BS 2484.

## FEATURES

Heavy duty, yet lightweight, these polyethylene cable covers incorporate a coloured printed warning tape.

- Rot resistant, chemical resistant from pH 2.5 to pH 11.
- High impact resistance.
- Ideal for electrical or fibre optic cables.
- Supplied with interlocking pegs for easy installation.
- Excellent protection properties.
- Visual warning.
- Low transportation and installation costs.
- Available up to 20 mm thick.
- Tensile Strength - 8 N/mm<sup>2</sup>
- Elongation at break - 200%.
- High chemical resistance.
- Light weight for vert easy handling and installation.
- Clearly printed with identifications or warning on bright red or yellow base coloration.
- Available as a simple but secure hole/peg joining system, giving a flexible but very strong joint.



## PE CABLE COVER TILE SIZES

Width	Thickness	Roll Length
150 mm	3 mm	1000 mm or 50 meter roll
200 mm	3 mm	1000 mm or 50 meter roll
150 mm	6 mm	1000 mm
200 mm	6 mm	1000 mm
240 mm	6 mm	1000 mm
150 mm	9-12 mm	1000 mm
200 mm	9-12 mm	1000 mm
240 mm	9-12 mm	1000 mm
300 mm	6 mm	1000 mm
300 mm	9-12 mm	1000 mm

## MATERIAL SPECIFICATION

Property	Test Method	Units	Value
Density	.....	Kg/m <sup>2</sup>	920
Tensile Strength	BS 2782 (320C)	N/mm <sup>2</sup>	8.4
Elongation at break	BS 2782 (320C)	%	230
Impact Strength	ASTM D & BS 2484	kg	5.0
Linear expansion coeff	ASTM D 696-79	mm/m2C	0.15
Flexural modulus	BS 2782 (335A)	Mpa	200

- Under ground field test
- Pick axe indentation < 2 mm
  - Fork indentation < 2.5 mm
  - Mechanical breaker penetration > 5 sec

## Important Note

All values shown are averages and should not be used for specification purposes.

Test data and test results contained in this document are for general information and it may vary from otest to another.



## HDPE Cable Protection Cover Tiles

### PROTECTION COVER TILES (HDPE)

The HDPE cable cover constitutes a cable warning, protection and marker system for use in all ground conditions. Being extremely tough and long lasting, they offer ideal protection to all underground services. Each tile is supplied with a peg, allowing for strong longitudinal joining for un-interrupted protection, unlike concrete tiles.

The polyethylene tiles are extremely tough and do not tend to crack. They comply with impact strength requirements for concrete tiles to BS 2484.



### FEATURES

Heavy duty, yet lightweight, HDPE cable covers incorporate a coloured printed warning tape.

- Rot resistant, chemical resistant from pH 2.5 to pH 11.
- High impact resistance.
- Ideal for electrical or fibre optic cables.
- Supplied with interlocking pegs for easy installation.
- Excellent protection properties.
- Visual warning.
- Low transportation and installation costs.
- Available up to 20 mm thick.
- Tensile Strength - 8 N/mm<sup>2</sup>
- Elongation at break - 200%.
- High chemical resistance.
- Light weight for vert easy handling and installation.
- Clearly printed with identifications or warning on bright red or yellow base coloration.
- Available in rolls 50 or 100 meters.



### PE CABLE COVER TILE SIZES

Width	Thickness	Roll Length
150 mm	2.0 mm	1000 mm or 50 meter roll
150 mm	2.5 mm	1000 mm or 50 meter roll
150 mm	2.7 mm	1000 mm or 50 meter roll
150 mm	4.0 mm	1000 mm or 50 meter roll
200 mm	2.0 mm	1000 mm or 50 meter roll
200 mm	2.5 mm	1000 mm or 50 meter roll
200 mm	2.7 mm	1000 mm or 50 meter roll
200 mm	4.0 mm	1000 mm or 50 meter roll
300 mm	2.0 mm	1000 mm or 50 meter roll
300 mm	2.5 mm	1000 mm or 50 meter roll
300 mm	2.7 mm	1000 mm or 50 meter roll
300 mm	4.0 mm	1000 mm or 50 meter roll

### MATERIAL SPECIFICATION

Property	Test Method	Units	Value
Density	.....	Kg/m <sup>2</sup>	935
Tensile Strength	BS 2782 (320C)	N/mm <sup>2</sup>	20
Elongation at break	BS 2782 (320C)	%	300
Impact Strength	ASTM D & BS 2484	kg	50
Linear expansion coeff	ASTM D 696-79	mm/m2C	0.2

### Important Note

All values shown are averages and should not be used for specification purposes.

Test data and test results contained in this document are for general information and it may vary from otest to another.



## Building Signs/Signage

Signs are so intricately woven into our society that many people do not even realize how often we use them. Whether they are commercial signs, directional signs or door signs, interior signage provides necessary communication and security. Door signage makes a first impression that can support the image of a business. A well designed and easy to read sign lets clients and associates know that you care about what you do and want to advertise your services clearly and with class. Our job is to make you look good through your signs. We offer a wide variety of plastic signs, engraved signs, framed signs and architectural signs with a fine balance of style and substance.

- Door Signs (Commercial & residential buildings).
- Reception Signs.
- Parking Signs (Commercial & residential buildings).
- Bathroom Signs.
- Restroom Signs.
- 3D Letter Signs.





## Construction Site Signage

These types of signs are ideal for construction sites and commercial business.

- (a) Project Sign Boards.
- (b) Site Safety Instruction Boards.
- (c) Safety Performance Boards.
- (d) Emergency Contact Records.
- (e) PPE Signage as per OSHA.
- (f) Temporary Traffic Signs.



### SITE SAFETY

	<b>Warning</b> Dangerous site, parents are advised to warn their children of the dangers of entering this site		<b>Danger</b> Demolition in progress
	<b>Safety helmets must be worn</b>		<b>Ear protectors must be worn</b>
	<b>Unauthorised entry to this site is strictly forbidden</b>		<b>High visibility jackets must be worn</b>
	<b>Protective footwear must be worn</b>		<b>Warning</b> Overhead loads



### MANDATORY SIGNS





## Acrylic Signage

Acrylic Sign are extremely functional, stylish, professional and totally customizable, The impression you create for your business relies heavily on your choice of business signage.

Custom acrylic signs are the perfect choice for establishing one's desired business image. Acrylic signs are highly durable and with a wide selection of colors to choose from, you can incorporate them into all aspects of your business advertising. Custom acrylic signs help create an upscale impression and are a powerful way of expressing your company's image through sophisticated signage. Whether you are applying acrylic letters to your business exterior, creating a monument or roadside sign, or using acrylic signs in a lobby or reception area, these signs give you and your business the exposure needed to succeed.



**ACRYLIC SIGNAGE**





## Safe Condition Signs

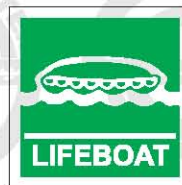
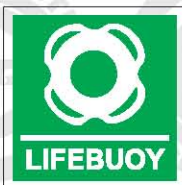

Available Standard Sizes (mm)

600x150	420x300	150x100	100x100
300x200	150x40	150x150	300x210
150x75	200x100	125x125	100x75

Safe Condition Signs available in both Arabic & English  
Custom graphics & signs also available.



# Warning Signs



Available Standard Sizes (mm)

600x150	420x300	150x100	100x100
300x200	150x40	150x150	300x210
150x75	200x100	125x125	100x75

Warning Signs available in both Arabic & English  
Custom graphics & signs also available.



## Mandatory Signs



Available Standard Sizes (mm)

600x150	420x300	150x100	100x100
300x200	150x40	150x150	300x210
150x75	200x100	125x125	100x75

Mandatory Signs available in both Arabic & English  
Custom graphics & signs also available.



# Prohibition Signs



Available Standard Sizes (mm)

600x150	420x300	150x100	100x100
300x200	150x40	150x150	300x210
150x75	200x100	125x125	100x75

Prohibition Signs available in both Arabic & English  
Custom graphics & signs also available.



## Multi Poster Signs



Multi Poster Signs available in both Arabic & English  
Custom graphics & signs also available.

## Multi Language Signs



Available Standard Sizes (mm)

600x150	420x300	150x100	100x100
300x200	150x40	150x150	300x210
150x75	200x100	125x125	100x75

Multi Language Signs available in both Arabic & English  
Custom graphics & signs also available.



## Fire Action & Equipment Signs



Multi Poster Signs available in both Arabic & English  
Custom graphics & signs also available.

## Fire Extinguisher Signs



Available Standard Sizes (mm)

600x150	420x300	150x100	100x100
300x200	150x40	150x150	300x210
150x75	200x100	125x125	100x75

Multi Language Signs available in both Arabic & English  
Custom graphics & signs also available.



## Safety Performance Boards

### HSE PERFORMANCE BOARD

MONTH :  YEAR :

	This Month	Last Month	Year to Date
TOTAL MAN HOURS :	<input type="text"/>	<input type="text"/>	<input type="text"/>
TOTAL MAN HOURS FREE LTI :	<input type="text"/>	<input type="text"/>	<input type="text"/>
ACCIDENT :	<input type="text"/>	<input type="text"/>	<input type="text"/>
NEARMISS :	<input type="text"/>	<input type="text"/>	<input type="text"/>
LOST TIME INJURY (LTI) :	<input type="text"/>	<input type="text"/>	<input type="text"/>

*"Safety does not come instantly, you should implement it consistently."*

### + SAFETY BOARD

THIS MONTHS LOST TIME INJURIES \_\_\_\_\_

THIS YEARS LOST TIME INJURIES \_\_\_\_\_

DAYS SINCE LOST TIME INJURY \_\_\_\_\_

PREVIOUS BEST \_\_\_\_\_

**SAFETY IS YOUR RESPONSIBILITY**

Safety Performance Boards available in both Arabic & English  
Custom graphics & signs also available.

## Permanent/Temporary Traffic Sign



ممنوع الانتظار  
No Waiting



ممنوع الوقوف والتوقف  
No Stopping



ممنوع الوقوف  
No Parking



ممنوع استعمال المنبه  
No Horn



ممنوع التجاوز  
No overtaking



قف  
STOP



قف  
STOP

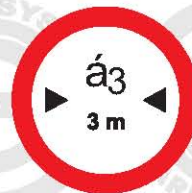

الحد الأقصى لعرض المركبة  
Max. Width Vehicle



الحد الأقصى لارتفاع المركبة  
Max. Height Vehicle



ممنوع للشاحنات  
Trucks Prohibited

Available Standard Sizes (mm)

600x150	420x300	150x100	100x100
300x200	150x40	150x150	300x210
150x75	200x100	125x125	100x75

Multi Language Signs available in both Arabic & English  
Custom graphics & signs also available.



# Maintenance Record Tapes

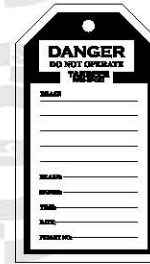

FIRE EXTINGUISHER INSPECTION RECORD			
EXTINGUISHER NO.			
2009	2010	2011	
JAN.			
FEB.			
MAR.			
APR.			
MAY.			
JUN.			
JUL.			
AUG.			
SEP.			
OCT.			
NOV.			
DEC.			

FIRE EXTINGUISHER INSPECTION TAG			
DATE	TYPE & ID NO. OF EXTINGUISHER	SIGN	STATUS

Safety Performance Boards available in both Arabic & English  
Custom graphics & signs also available.

# Photoluminescent Signs



LIFEBUOY



LIFEBUOY AND ROPE

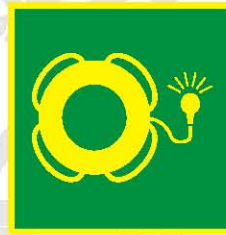

LIFEBUOY AND LIGHT

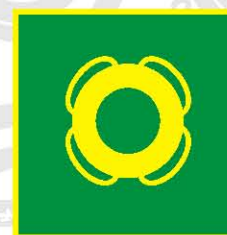

LIFEBUOY



LIFEBUOY, LIGHT & SMOKE



LIFE JACKET



IMMERSION SUIT

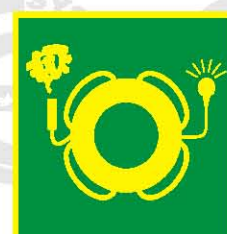

LIFEBUOY, LIGHT & SMOKE

Multi Language Signs available in both Arabic & English  
Custom graphics & signs also available.

Available Standard Sizes (mm)

600x150	420x300	150x100	100x100
300x200	150x40	150x150	300x210
150x75	200x100	125x125	100x75



## Safety Labels & Induction Stickers



Safety Labels & Induction Stickers available in both Arabic & English  
Custom graphics & signs also available.



## Specialized Engraving, Embossing & Etching

Engraving and marking produces an accurate and permanent mark to a variety of materials. Applications for laser engraving and marking are wide and varied from industrial applications of compliance plates, identification and serial number tags and branding to graphic application of replicating photographs and images and promotional applications that include etching of glassware, bottles and photo frames.





## Specialized Engraving, Embossing & Etching

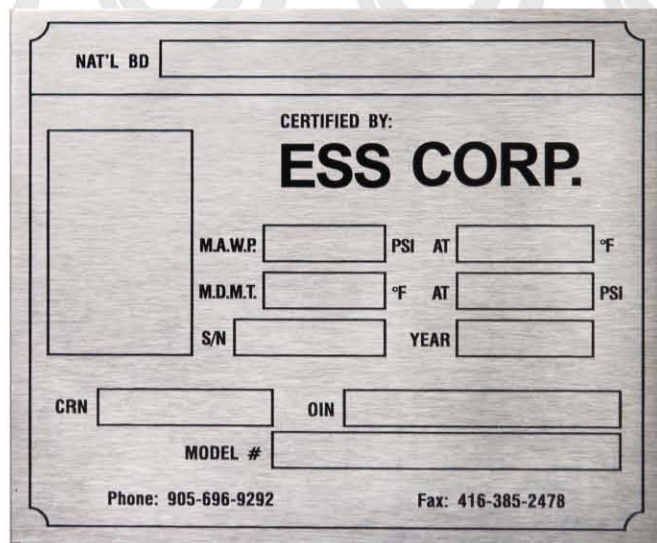
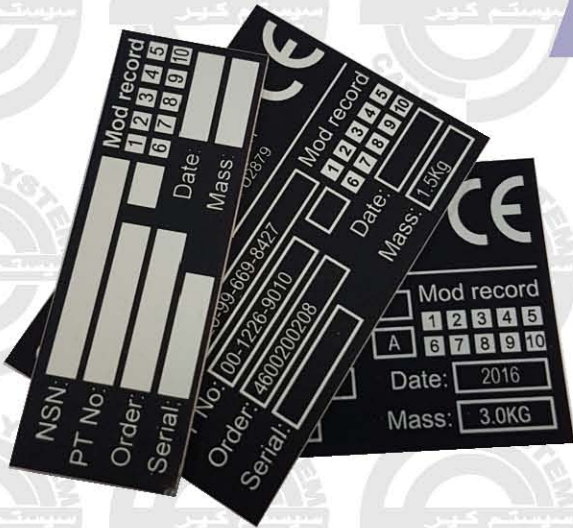



## Specialized Engraving, Embossing & Etching

Materials suitable for engraving and marking include:

- Traffolyte / PVC
- Anodized aluminium
- Stainless steel 316 & 304
- Brass
- Metal photo aluminium
- Mild steel
- Coated metals (Powder coated, Painted and Screen Printed)
- Acrylic

### SS Laser Marking



### Screen Printing

**Designed & Assembled by:**  
  
 أكمي للمفاتيح الكهربائية ذ.م.م.  
**ACME Electric Switchgear L.L.C.**  
 ACME Group of Companies

<b>Head Office</b>	<b>Factory Office</b>
Tel : +971 2 5545801	Tel: +971 2 5514151
Fax : +971 2 5545804	Fax: +971 2 5514132
P.O.Box: 27629 - Abu Dhabi U.A.E.	
acmesg@eim.ae, acmesg@gmail.com, info@acmegroupsuae.com	
<a href="http://www.acmegroupsuae.com">www.acmegroupsuae.com</a>	

**Designed and assembled by:**  
 مركز الانارة - سرفوماتيك  
**ILLUMINATION CENTRE EST. (SERVAUMATIC)**  

<b>Head Office</b>	<b>Factory Office</b>
Tel.: 02 6329800	Tel.: 02 5575666
Fax: 02 6325454	Fax: 02 5512323
P.O. Box: 2421, Abu Dhabi, U.A.E.	
E-mail: infoilluminationcentre.ae, www.illuminationcentre.ae	

### Safety Jacket & Coverall Printing





### Switch Marking & Face Plate Cutting



### Digital Printing

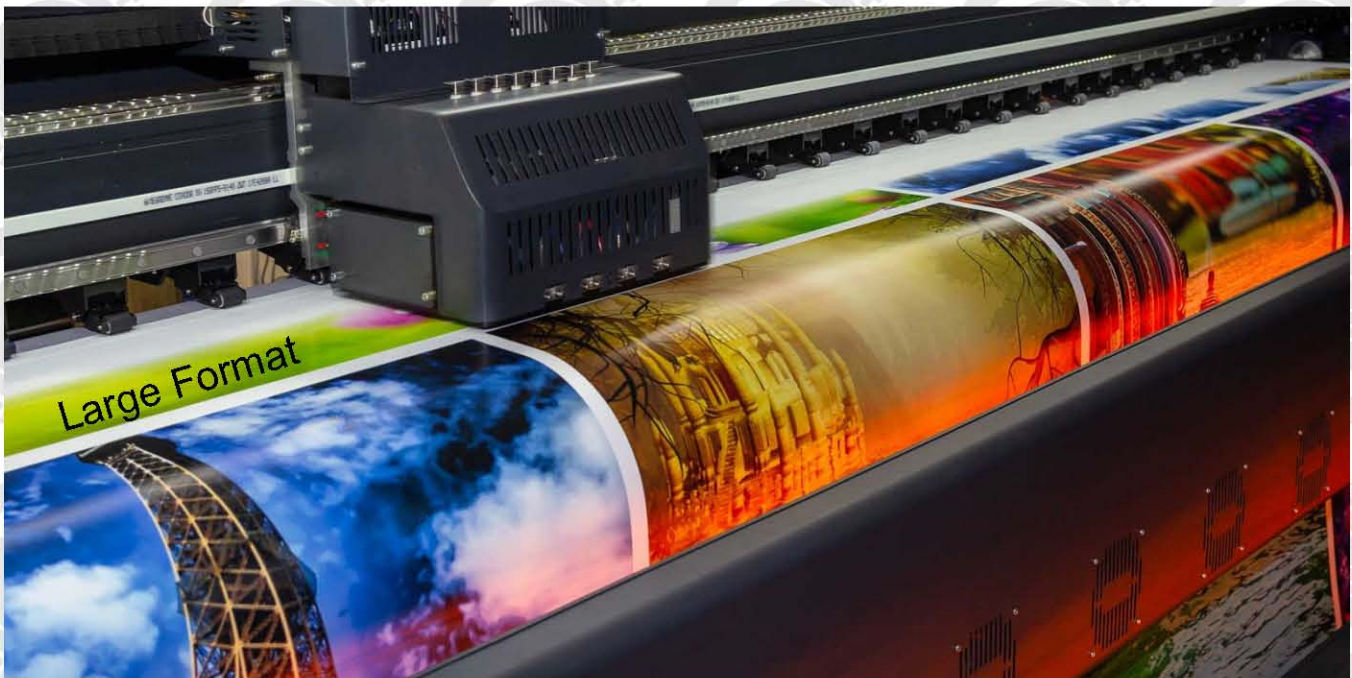

- Banner
- Flyer
- Pop up
- Out Door Signs
- Roll up
- Sticker
- Poster
- Indoor Signs



## Engraving Traffolyte Labels and Signage

Rigid laminates formerly known as "Traffolyte" are like a "sandwich" structure where the top layer is cut away to expose the layer underneath, Engraving can be done on either side.

Example: Red/White/Red. The top colour, red, is the face colour on either side, Middle colour is white, the colour of the core, which will be visible when engraved.

**Rigid engraving laminates are available from stock in the following colour combinations:**

- White/Black/White
- White/Red/White
- White/Blue/White
- White/Green/White
- Yellow/Black/Yellow
- Red/White/Red
- Blue/White/Blue
- Black/White/Black(Matt/Semi Gloss Finish)
- Green/White/Green
- Gold/White/Silver (Reversible)

Traffolyte engraving laminated are typically available in thicknesses of 1.5 mm and 3 mm . These laminates are best suited for fixing to a flat surface and have little flexibility.

### Fixing Methods

Engraved traffolyte labels can be pre-drilled, adhesive backed or both to suit individual requirements. in most cases 3.5 mm or 4 mm diameter fixing holes are recommended. Sign holders, frames or mounting hardware are also available.

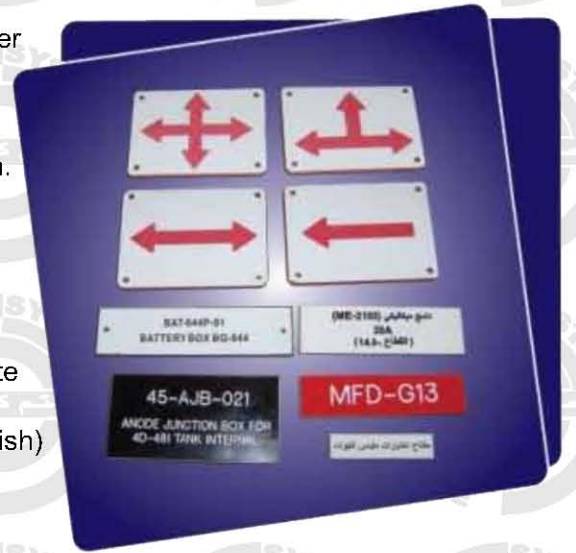

White/Red/White Engraved Traffolyte



Blue/White/Blue Engraved Traffolyte



Red/White/Red Engraved Traffolyte



Valve Tag Engraved Traffolyte



Valve Tag Engraved Traffolyte



Yellow/Black/Yellow Engraved Traffolyte



Black/White/Black Engraved Traffolyte



Green/White/Green Engraved Traffolyte



## Engraving PVC Labels and Signage

ABS laminates are more flexible than rigid laminates and are commonly known as PVC sheets. The physical properties of these materials are largely controlled by the base material. This material was chosen to provide a good balance of properties for the product to satisfy a wide range of uses. The material softens at about 93°C sufficiently so that it can be bent where needed. It can be drilled, sawed, sheared, nailed, bonded and die-cut. The base material, as well as the foils, were tested for flammability by Underwriters Laboratories. The base material is rated as 94 HB on the UL 94 test. The foil was judged as not contributing to combustion of the base. Most of the colors will exhibit slight fading under prolonged exposure to direct sunlight. This material is designed for use where no direct exposure to sunlight is encountered.



**PVC engraving laminates are available in stock in the following colour combinations:**

- White/Black
- White/Red
- White/Green
- Black/White
- Blue/White
- Red/White
- White/Blue
- Red/Black
- Grey/Black

PVC engraving laminates used are typically 1.5 mm thick, 3 mm is also available.

### Fixing Methods

Engraved PVC labels can be pre-drilled, adhesive backed or both suit individual requirements. In most cases 3.5 mm or 4 mm diameter fixing holes are recommended. Sign holders, frames or mounting hardware are also available.

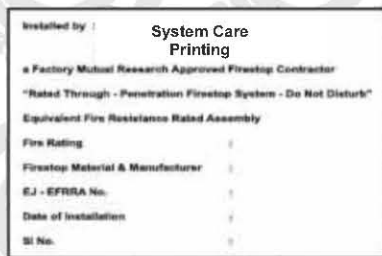

**White Base Black Letter Engraved PVC**

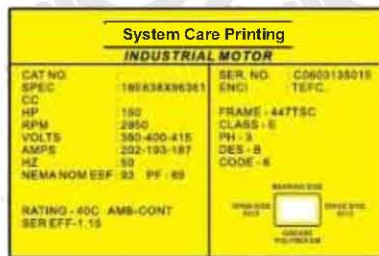

**Yellow Base Black Letter Engraved PVC**



**Red Base White Letter Engraved PVC**

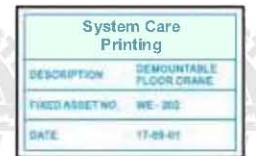

**White Base Blue Letter Engraved PVC**

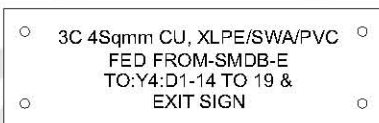

**White Base Black Letter Engraved PVC**



**Black Base White Letter Engraved PVC**

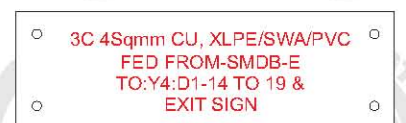

**White Base Red Letter Engraved PVC**

### Engraved PVC Valve Tags





## Engraving Acrylic Labels and Signage

There are many distinct characteristics to take into account when considering acrylic for your signage needs. Acrylic signs are notable for the acrylic's clarity and color range, Acrylic signs are extremely durable and provide electronic component protection. Additional characteristics for acrylic signs include their lightweight & aesthetic appeal, dimensional stability, breakage and weather resistance, resistance to harsh environments, chemical but not solvent resistance, The ability to produce and fabricate quality acrylic signage with completely customized graphics and mounting options are only one of the many advantages we provide.

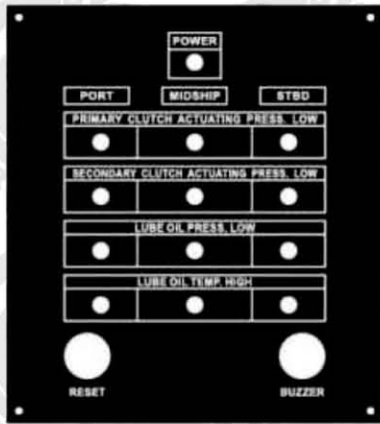

Black Base White Letter  
Engraved Acrylic



Yellow Base Black Letter  
Engraved Acrylic



Green Base White Letter  
Engraved Acrylic

### Engraved Acrylic Valve Tags & Tool Tokens



Red Base White Letter  
Engraved Acrylic

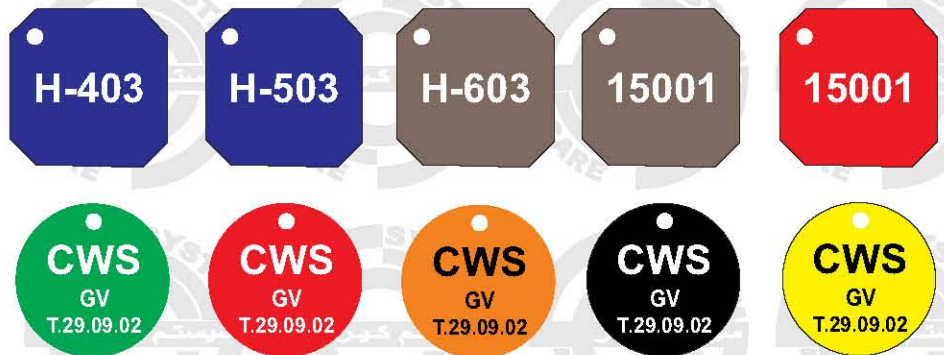

White Base Black Letter  
Engraved Acrylic



White Base Red Letter  
Engraved Acrylic



Black Base White Letter  
Engraved Acrylic



## Engraved Aluminum and Signage

Aluminum is an ideal choice of material for both outdoor and indoor signs and labels because of its durable non-corrosive properties. Aluminum is light weight and tough, and can be etched as well as engraved. Our aluminum signs are available in raw, anodized and black anodized finish. Aluminum can be machine engraved or laser engraved. Both methods are very durable and effective. We can also machine cut or laser cut to any shape or pattern required. Aluminum may be considered as an alternative to stainless steel and some other heavier metals and it maintains its durability.

Common thicknesses available are 1 mm/1.5 mm/2 mm/3 mm. Other thicknesses are available by special order. We engrave and paint fill in any color that is required.

### Fixing Methods

Engraved aluminum labels can be pre-drilled, adhesive backed or both to suit individual requirements. In most cases 3.5 mm or 4 mm diameter fixing holes are recommended. Sign holders, frames or mounting hardware are also available.



Engraved Black Anodized Aluminum Plate



Engraved Aluminum Plate



Engraved Anodized Aluminum Plate



Engraved Anodized Aluminum Plate

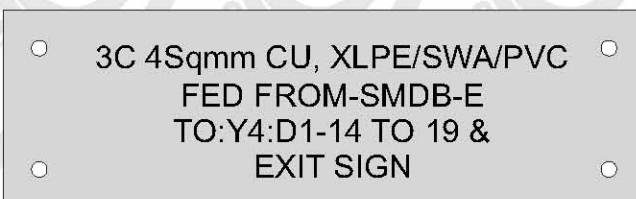

Engraved Anodized Aluminum Cable Label

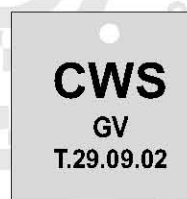

Engraved Aluminum Valve Tag



Engraved Anodized Aluminum Valve Tag



## Engraving Stainless Steel Labels and Signage

Stainless steel signs are known for their excellent abrasion and chemical resistance. In environments where exposure to a corrosive atmosphere of any kind is likely, stainless steel is, in most cases, the material of choice. Stainless steel is strong, durable and scratch resistant, and as such is used in a variety of signs. Stainless steel offers an unsurpassed, clean, sharp and detailed appearance that stands out in any application. Stainless steel signs are highly resistant to heat, adoration and chemicals and are ideal for use in the most rigorous environments. Our stainless steel labels are an excellent choice for signs for business, door signs, hotel signs, outdoor signs, commercial signs, walls, panels or

use. Our stainless steel signs are available in 316 & 304 Grade with brush/matt/mirror finish.

### Fixing Methods

Engraved aluminum labels can be pre-drilled, adhesive backed or both to suit individual requirements. In most cases 3.5 mm or 4 mm diameter fixing holes are recommended. Sign holders, frames or mounting hardware are also available.



### Engraved Stainless Steel Plates

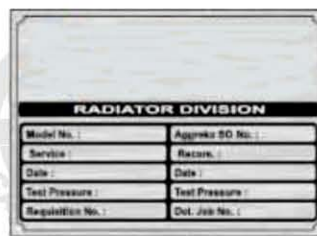
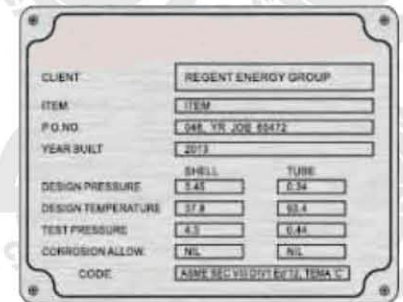
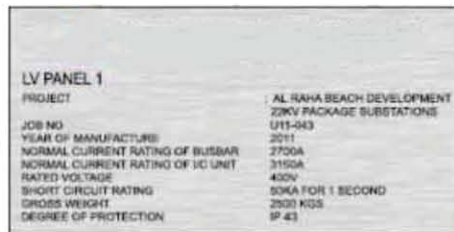
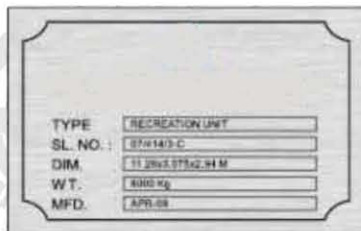

### Engraved Stainless Steel Labels

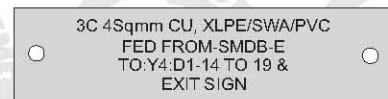
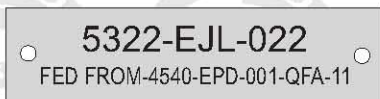

### Engraved Stainless Steel Valve Tags

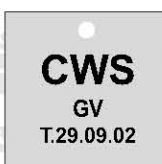



## Engraved Brass Labels & Signage

The rich appearance provided by brass is difficult to duplicate with other metals. Brass not only offers elegance and style but is also suitable for harsh indoor and outdoor environments. Brass nameplates may be polished to a gold-like appearance or given a satin (brushed) finish. In addition to the classic finish option a brass nameplate can be selected to weather naturally (due to oxidation) or instead to be protected by a clear coat. Brass tags by their nature allow items to be clearly marked. The benefits are that they are long lasting, have a high quality finish and are reasonably priced. The main feature of brass is that it can be engraved or laser etched. Engraving is the more durable of the two. Brass plaques are frequently manufactured by us and are usually fitted to a wooden plaque. It also looks good when mounted on a wall and lasts for many years. Shields and presentation awards are also a popular use of brass nameplates because of its association with style and elegance.

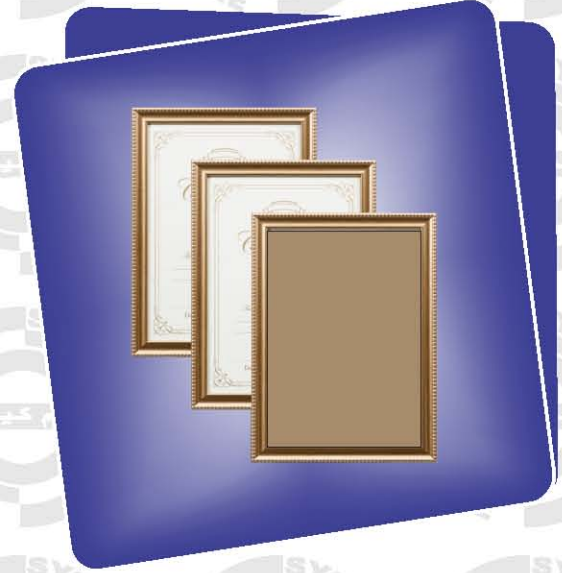

### Fixing Methods

Engraved aluminum labels can be pre-drilled, adhesive backed or both to suit individual requirements. In most cases 3.5 mm or 4 mm diameter fixing holes are recommended. Sign holders, frames or mounting hardware are also available.

### Engraved Brass Plates & Labels

5322-EJL-022 FED FROM-4540-EPD-001-QFA-11	5322-EJL-022 FED FROM-4540-EPD-001-QFA-11	5322-EJL-022 FED FROM-4540-EPD-001-QFA-11	5322-EJL-022 FED FROM-4540-EPD-001-QFA-11
5322-EJL-022 FED FROM-4540-EPD-001-QFA-11	5322-EJL-022 FED FROM-4540-EPD-001-QFA-11	5322-EJL-022 FED FROM-4540-EPD-001-QFA-11	5322-EJL-022 FED FROM-4540-EPD-001-QFA-11
5322-EJL-022 FED FROM-4540-EPD-001-QFA-11	5322-EJL-022 FED FROM-4540-EPD-001-QFA-11	5322-EJL-022 FED FROM-4540-EPD-001-QFA-11	5322-EJL-022 FED FROM-4540-EPD-001-QFA-11



## سیستم کیر للطباعة

### System Care Printing

Tel : +971 2 6797507, Mob: +971 55 3115259, P.O Box: 53173, Musaffah Industrial Area (M-39)  
E-mail: systemcareprinting@gmail.com www.systemcarep.com

### Engraved Brass Valve Tags

CWS GV T.29.09.02	CWS GV T.29.09.02	CWS GV T.29.09.02	CWS GV T.29.09.02	CWS GV T.29.09.02	CWS GV T.29.09.02	CWS GV T.29.09.02	CWS GV T.29.09.02
-------------------------	-------------------------	-------------------------	-------------------------	-------------------------	-------------------------	-------------------------	-------------------------



# Engraved Valve Tag

Our valve tags are ideal for any pipe and valve identification programs. It is a quick and easy way to properly identify all valves, pipes and lines running through the facility. We produce a variety of different valve tags in an assortment of materials. The most popular are aluminum, stainless steel, brass, PVC, Acrylic and traflowite. We also provide colored metal valve tags according to different services as per the identification color code standards.

Standard sizes of valve tags are 30 mm, 40 mm or 50 mm diameter and come pre-drilled with a 4 mm hole at top center.

We carry in stock the following items which can be successfully

### Fixing Methods

We carry in stock the following items which can be successfully used as fixings:

- Chrome plated brass ball chain and connectors.
- Stainless steel ball chain and connectors.
- Stainless steel binding wire.
- 20 mm split rings/key rings.
- Plastic cable ties.





## Metal Photo Aluminum Nameplates

A metal photo aluminum nameplate is the most durable type of aluminum nameplate product offered. It has the highest resolution capability of any aluminum substrate by providing photographic levels of detail. We are able to produce quality metal photo aluminum nameplate to meet your exact specifications. Metal photo aluminum nameplates thrive under challenging environments. It is also known as UV protected electro processed aluminum labels (which can be exposed to chemicals & alkalis) that ensure permanence.

A metal photo aluminum nameplate meets the most stringent standards for durability and quality appearance. The most popular applications for this product include marine, military and aerospace. Additional uses include specification plates, equipment tags, asset schematics, variable information plates, equipment tags, asset tags, medical/autoclave tag and even artistic paintings.



## Engraved Mimic and Fascia Panels



Mimic diagrams/fascia panels can be manufactured from a variety of materials including stainless steel, anodised aluminum, metal photo aluminum, traffolite, PVC and acrylic. With reverse engraving being the most versatile, it is often the most popular choice with options for colours and logos being almost endless. All mounting holes or "cut-outs" are CNC machined in house to ensure repeatability and accuracy. We can typically machine to a tolerance of 0.1 mm in both diameter and depth.





## Cable Identification Tags/Markers

Our cable identification tags/markers are available in two types: Engraved & Embossed. Engraved cable identification tags are made from PVC, stainless steel or aluminum. Embossed 316 stainless steel cable markers incorporate raised sections to allow fixing with stainless steel cable ties or plastic cable ties onto cables. The markers are resistant to chemicals, UV exposure and high temperatures.

### Fixing Methods

- Stainless steel cable ties
- Stainless steel binding wire
- Plastic cable ties.

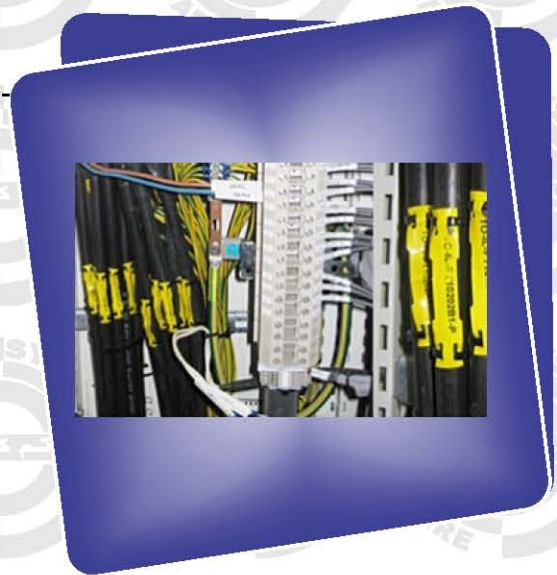

Dog tags are also available in stainless steel & aluminum.



**Embossed Cable Tag**



## Laser Engraving

Laser engraving is the practice of using lasers to engrave or mark an object. The technique does not involve the use of inks nor does it involve tool bits which contact the engraving surface. Laser engraving produces a mark that is crisp, clean and permanent. Lasers are also faster than many conventional methods of product imprinting, providing greater versatility in material choices. The same machine can also cut through thin materials as well as engrave on them. We can laser engraved on a variety of materials and products including:-



- Switch Plates
- Pens
- Key Rings
- Torches
- Photo Frames
- Travel Mugs
- Clocks
- Aluminum
- Stainless Steel
- Acrylic
- PVC